

MADERA

collection



BARVY



00.
přírodní



01.
vlašský ořech



02.
borovice



03.
teak



04.
dub



05.
kaštanová



09.
mahagon



10.
wenge

Hladká tyč

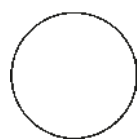

REF.	<---->			A	B
1730**4	1,80 m.	x 6		866 Kč/Ks	849 Kč/Ks
1731**4	2,10 m.	x 6		1.006 Kč/Ks	986 Kč/Ks
1749**4	2,40 m.	x 6		1.146 Kč/Ks	1.123 Kč/Ks
1732**4	3,00 m.	x 6		1.424 Kč/Ks	1.395 Kč/Ks
1759**4	3,60 m.	x 6		1.710 Kč/Ks	1.677 Kč/Ks

Žebrovaná tyč

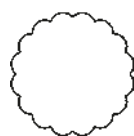

REF.	<---->			A	B
1733**4	1,80 m.	x 6		880 Kč/Ks	862 Kč/Ks
1734**4	2,10 m.	x 6		1.023 Kč/Ks	1.003 Kč/Ks
1748**4	2,40 m.	x 6		1.171 Kč/Ks	1.149 Kč/Ks
1735**4	3,00 m.	x 6		1.450 Kč/Ks	1.421 Kč/Ks
1792**4	3,60 m.	x 6		1.742 Kč/Ks	1.707 Kč/Ks

Pruhovaná tyč

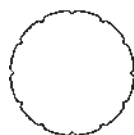

REF.	<---->			A	B
1736**4	1,80 m.	x 6		886 Kč/Ks	868 Kč/Ks
1737**4	2,10 m.	x 6		1.022 Kč/Ks	1.001 Kč/Ks
1794**4	2,40 m.	x 6		1.165 Kč/Ks	1.143 Kč/Ks
1738**4	3,00 m.	x 6		1.448 Kč/Ks	1.419 Kč/Ks
1795**4	3,60 m.	x 6		1.740 Kč/Ks	1.705 Kč/Ks

** Barvy A: 01= vlašský ořech. 02= borovice. 03= teak. 04= dub. 05= kaštanová. 09= mahagon. 10= wenge (barvy 10 hladká tyč)

** Barvy B: 00= přírodní.

Kód obalu: 4= ochranný obal.

Příslušenství 50 mm

Kroužek leštěný



REF. **1812**0**

x 120

A 31 Kč/Ks
B 30 Kč/Ks

Kroužek leštěný, oválný



REF. **1729**0**

x 120

62 Kč/Ks
60 Kč/Ks

Leštěný kroužek skládaný



REF. **1746**0**

x 120

62 Kč/Ks
60 Kč/Ks

Držák otevřený "P"



REF. **1790**0**

x 12

A 279 Kč/Ks
B 273 Kč/Ks

Držák otevřený "G"



REF. **1791**0**

x 12

461 Kč/Ks
452 Kč/Ks

Držák koncovkový



REF. **1796**0**

x 36

189 Kč/Ks
185 Kč/Ks

Držák posuvný



REF. **3381**0**

x 12

A 442 Kč/Ks
B 433 Kč/Ks

Příslušenství k posuvnému držáku 50-35
(pro použití s držákem 3381**0)



REF. **3380**0**

x 12

111 Kč/Ks
108 Kč/Ks

Koncovky 50 mm

Koncovka koule "P"



Koncovka koule "G"



Koncovka "BELLOTA"



REF. 1750**0



x 12

REF. 1786**0

x 12

REF. 1789**0

x 12

A 162 Kč/Ks
B 159 Kč/Ks

A 302 Kč/Ks
B 296 Kč/Ks

A 194 Kč/Ks
B 190 Kč/Ks

Koncovka "COPA"



Koncovka "MOSCÚ"



Koncovka "REY"



REF. 1787**0



x 12

REF. 1788**0

x 12

REF. 1713**0

x 12

A 345 Kč/Ks
B 337 Kč/Ks

A 331 Kč/Ks
B 324 Kč/Ks

A 301 Kč/Ks
B 295 Kč/Ks

Koncovka "DOMO"

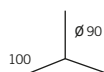

REF. 1708**0



x 12

A 260 Kč/Ks
B 255 Kč/Ks

** Barvy A: 01= vlašský ořech. 02= borovice. 03= teak. 04= dub. 05= kaštanová. 09= mahagon. 10= wenge (barvy 10 hladká tyč)
** Barvy B: 00= přírodní.
Kód obalu: 0= velikost



Speciální barvy - základní



06.
Bílá



79.
Krémová

Speciální barvy - patina



88.
Bílo-zlatá



89.
Bílo-stříbrná



69.
Wenge-zlatá



73.
Wenge-stříbrná



62.
Krémovo-zlatá



87.
Krémovo-stříbrná

Hladká tyč - speciální barvy, 50 mm

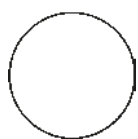

REF.	<----->			základní	patina
1730**4	1,80 m.	x 6		996 Kč/Ks	1.083 Kč/Ks
1749**4	2,40 m.	x 6		1.318 Kč/Ks	1.433 Kč/Ks
1732**4	3,00 m.	x 6		1.638 Kč/Ks	1.780 Kč/Ks

Kód obalu: 4= ochranný obal.

Příslušenství a koncovky - speciální barvy, 50 mm

Kroužek lakovaný / leštěný



Ø Int. 68
Ø Ext. 93

— lakovaný — — leštěný —

Držák otevřený "G"



190
130
Ø 92

Držák otevřený "P"



170
120
Ø 75

REF.	1813**0	1812690	1812730	1791**0	1790**0
	x 120	x 120	x 120	x 12	x 12
A	43 Kč/Ks	-	-	508 Kč/Ks	307 Kč/Ks
B	50 Kč/Ks	38 Kč/Ks	38 Kč/Ks	576 Kč/Ks	348 Kč/Ks

Koncovka koule "G"



123
Ø 90

Koncovka koule "P"



105
Ø 74

Koncovka "DOMO"



100
Ø 90

REF.	1786**0	1750**0	1708**0
	x 12	x 12	x 12
A	332 Kč/Ks	178 Kč/Ks	286 Kč/Ks
B	378 Kč/Ks	201 Kč/Ks	325 Kč/Ks

Koncovka "MOSCÚ"



146
Ø 90

Koncovka "COPA"



154
Ø 92

Koncovka "BELLOTA"



151
Ø 74

REF.	1788**0	1787**0	1789**0
	x 12	x 12	x 12
A	364 Kč/Ks	378 Kč/Ks	214 Kč/Ks
B	414 Kč/Ks	430 Kč/Ks	243 Kč/Ks

** Barvy: **A**= Speciální barvy - základní. **B**= Speciální barvy - patina.
Kód obalu: **O**= velikost

BARVY



01.
vlašský ořech



02.
borovice



03.
teak



04.
dub



05.
kaštanová

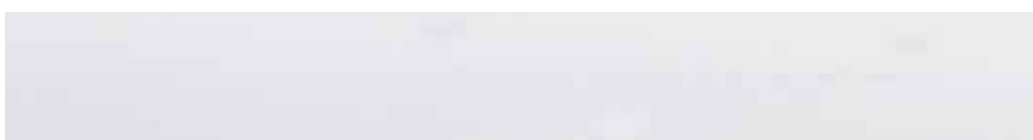

06.
bílá



09.
mahagon



10.
wenge



Novinka
79.
krémová

Lakované dřevo 35 mm: (s kroužky a koncovkami "Chyc")

Dřevěná tyč "EXTRA"



REF.	←----→		A	B	REF.	←----→		A	B
0794**4	1,50 m.	x 4	1.060 Kč/Ks	1.219 Kč/Ks	0794**2	1,50 m.	x 6	1.231 Kč/Ks	1.416 Kč/Ks
0763**4	1,80 m.	x 4	1.158 Kč/Ks	1.331 Kč/Ks	0763**2	1,80 m.	x 6	1.351 Kč/Ks	1.553 Kč/Ks
0764**4	2,10 m.	x 4	1.281 Kč/Ks	1.473 Kč/Ks	0764**2	2,10 m.	x 6	1.497 Kč/Ks	1.722 Kč/Ks
0765**4	2,40 m.	x 4	1.512 Kč/Ks	1.738 Kč/Ks	0765**2	2,40 m.	x 6	1.770 Kč/Ks	2.035 Kč/Ks
0767**4	3,00 m.	x 4	1.726 Kč/Ks	1.985 Kč/Ks	0885**2	3,00 m. (2 tyče po 1,50 m)	x 6	1.927 Kč/Ks	2.216 Kč/Ks
0769**4	3,60 m. (2 tyče po 1,80 m)	x 4	1.943 Kč/Ks	2.235 Kč/Ks	0769**2	3,60 m. (2 tyče po 1,80 m)	x 6	2.175 Kč/Ks	2.502 Kč/Ks

POZNÁMKA: u tyčí delších jak 2,4 m jsou 3 držáky

Lakované dřevo 35 mm: (s kroužky a koncovkami "Lisboa")

Dřevěná tyč "EXTRA"



REF.	←----→		A	REF.	←----→		A
2274**4	1,50 m.	x 4	1.030 Kč/Ks	2274**2	1,50 m.	x 6	1.154 Kč/Ks
2275**4	1,80 m.	x 4	1.100 Kč/Ks	2275**2	1,80 m.	x 6	1.383 Kč/Ks
2276**4	2,10 m.	x 4	1.225 Kč/Ks	2276**2	2,10 m.	x 6	1.540 Kč/Ks
2277**4	2,40 m.	x 4	1.428 Kč/Ks	2277**2	2,40 m.	x 6	1.803 Kč/Ks
2278**4	3,00 m.	x 4	1.644 Kč/Ks	2278**2	3,00 m. (2 tyče po 1,50 m)	x 6	1.962 Kč/Ks
2279**4	3,60 m. (2 tyče po 1,80 m)	x 4	1.875 Kč/Ks	2279**2	3,60 m. (2 tyče po 1,80 m)	x 6	2.232 Kč/Ks

POZNÁMKA: u tyčí delších jak 2,4 m jsou 3 držáky

Hladké dřevěné tyče 35 mm

Dřevo "EXTRA"



Dřevo "SAMBA"



REF.	←----→		A	B	REF.	←----→		A	B
1760**3	1,50 m.	x 12	318 Kč/Ks	366 Kč/Ks	1133**3	1,50 m.	x 12	236 Kč/Ks	283 Kč/Ks
1761**3	1,80 m.	x 12	377 Kč/Ks	433 Kč/Ks	1134**3	1,80 m.	x 12	284 Kč/Ks	341 Kč/Ks
1762**3	2,10 m.	x 12	441 Kč/Ks	507 Kč/Ks	1135**3	2,10 m.	x 12	330 Kč/Ks	396 Kč/Ks
1763**3	2,40 m.	x 12	503 Kč/Ks	578 Kč/Ks	1136**3	2,40 m.	x 12	376 Kč/Ks	451 Kč/Ks
1764**3	2,70 m.	x 12	564 Kč/Ks	648 Kč/Ks	1137**3	2,70 m.	x 12	422 Kč/Ks	507 Kč/Ks
1765**3	3,00 m.	x 12	630 Kč/Ks	724 Kč/Ks	1138**3	3,00 m.	x 12	470 Kč/Ks	564 Kč/Ks

** Barvy A: 01= vlašský ořech. 02= borovice. 03= teak. 04= dub. 05= kaštanová. 09= mahagon. 10= wenge

** Barvy B: 06= bílá. 79= krémová. (na objednávku)

Kód obalu: 2= blister. 3= zavírací obal. 4= ochranný obal.

Lakované držáky a kroužky, 35 mm

Kroužek s očkem



Ø Int. 53
Ø Ext. 75

Kroužek s očkem

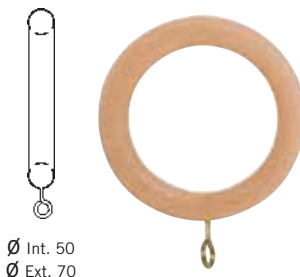

Ø Int. 50
Ø Ext. 70

Kroužek bez očka

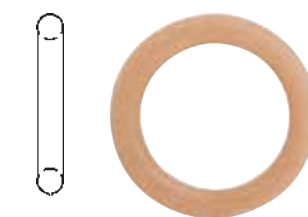

Ø Int. 53
Ø Ext. 75

REF.	0302**0	0304**0	0878**2	0879**2	0046**0
	x 275	x 275	x 10	x 10	x 275
A	17 Kč/Ks	-	249 Kč/bl.	-	16 Kč/Ks
B	-	23 Kč/Ks	-	301 Kč/bl.	-

Lesklý plastový kroužek bez očka

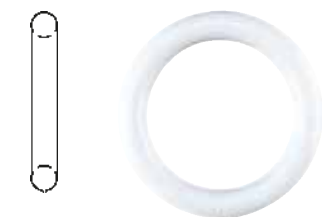

Ø Int. 50
Ø Ext. 70

Kroužek "LISBOA"



Ø Int. 50
Ø Ext. 70

Držák otevřený

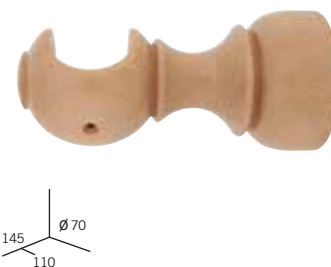

REF.	1443060	1931**0	0175**0	0175**2
	x 275	x 275	x 50	x 2
A	-	17 Kč/Ks	139 Kč/Ks	352 Kč/bl.
B	14 Kč/Ks	18 Kč/Ks	153 Kč/Ks	387 Kč/bl.

Dvoj držák otevřený 35-20



Ø 70
185
150 70

Dvoj držák otevřený 35-35



Ø 70
185
150 70

Držák otevřený "LISBOA"



Ø 50
130
98

REF.	1453**0	1452**0	1452**2	1604**0	1604**2
	x 25	x 25	x 1	x 50	x 1
A	211 Kč/Ks	201 Kč/Ks	291 Kč/bl.	103 Kč/Ks	163 Kč/bl.
B	231 Kč/Ks	222 Kč/Ks	321 Kč/bl.	114 Kč/Ks	180 Kč/bl.

** Barvy A: 01= vlašský ořech. 02= borovice. 03= teak. 04= dub. 05= kaštanová. 09= mahagon. 10= wenge
** Barvy B: 06= bílá. 79= krémová. (na objednávku)
Kód obalu: 0= velikost. 2= blister.

Lakované držáky 35 mm

Dvoj držák otevřený 35-35 "LISBOA"

Příslušenství k posuvnému držáku 35-20 (pro použití s držákem 0183**0/0183**2)

Rohový nástěnný držák

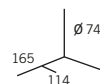

REF.	0300**0	0300**2	0535**0	0295**0	0295**2
------	---------	---------	---------	---------	---------

	x 25	x 1	x 25	x 25	x 1
--	------	-----	------	------	-----

	A 121 Kč/Ks	193 Kč/bl.	63 Kč/Ks	191 Kč/Ks	292 Kč/bl.
	B 134 Kč/Ks	213 Kč/bl.	69 Kč/Ks	211 Kč/Ks	322 Kč/bl.

Držák koncovkový

Držák koncovkový "LISBOA"

Stropní držák "LISBOA"

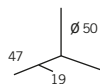
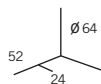

REF.	1499**0	1499**2	0306**0	0306**2	0307**0	0307**2
------	---------	---------	---------	---------	---------	---------

	x 25	x 2	x 25	x 2	x 50	x 1
--	------	-----	------	-----	------	-----

	A 73 Kč/Ks	213 Kč/bl.	60 Kč/Ks	162 Kč/bl.	95 Kč/Ks	258 Kč/bl.
	B 80 Kč/Ks	233 Kč/bl.	66 Kč/Ks	179 Kč/bl.	104 Kč/Ks	283 Kč/bl.

Stropní držák

Stropní držák rohový

Držák posuvný

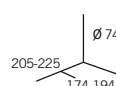

REF.	0564**0	0564**2	0294**0	0294**2	0183**0	0183**2
------	---------	---------	---------	---------	---------	---------

	x 50	x 2	x 50	x 1	x 25	x 1
--	------	-----	------	-----	------	-----

	A 118 Kč/Ks	340 Kč/bl.	118 Kč/Ks	178 Kč/bl.	171 Kč/Ks	265 Kč/bl.
	B 130 Kč/Ks	374 Kč/bl.	129 Kč/Ks	195 Kč/bl.	188 Kč/Ks	291 Kč/bl.

** Bary A: 01= vlašský ořech. 02= borovice. 03= teak. 04= dub. 05= kaštanová. 09= mahagon. 10= wenge

** Bary B: 06= bílá. 79= krémová. (na objednávku)

Kód obalu: 0= velikost. 2= blister.

Lakované koncovky 35 mm

Koncovka "CHYC"



Koncovka "MOTRIL"



Koncovka "NERJA"



REF.	0177**0	0177**2	0163**0	0163**2	0162**0	0162**2
	x 50	x 2	x 50	x 2	x 50	x 2
A	82 Kč/Ks	259 Kč/bl.	74 Kč/Ks	198 Kč/bl.	72 Kč/Ks	194 Kč/bl.
B	90 Kč/Ks	285 Kč/bl.	82 Kč/Ks	219 Kč/bl.	79 Kč/Ks	214 Kč/bl.

Koncovka "LISBOA"



Koncovka "ESFERA"



Koncovka "ESFERA CON BOTÓN"



REF.	1613**0	1613**2	1476**0	1476**2	1468**0	1468**2
	x 50	x 2	x 50	x 2	x 50	x 2
A	56 Kč/Ks	188 Kč/bl.	57 Kč/Ks	214 Kč/bl.	56 Kč/Ks	216 Kč/bl.
B	62 Kč/Ks	206 Kč/bl.	63 Kč/Ks	236 Kč/bl.	62 Kč/Ks	237 Kč/bl.

Koncovka "ESPECIAL"



REF.	1485**0	1485**2
	x 50	x 2
A	37 Kč/Ks	134 Kč/bl.
B	41 Kč/Ks	148 Kč/bl.

** Bary A: 01= vlašský ořech. 02= borovice. 03= teak. 04= dub. 05= kaštanová. 09= mahagon. 10= wenge
 ** Bary B: 06= bílá. 79= krémová. (na objednávku)
 Kód obalu: 0= velikost. 2= blister.

Leštěné dřevo, 35 mm

(s kroužky a koncovkami "Granada")

Dřevo "EXTRA"



REF.	<---->			01/ 02/ 03	REF.	<---->			01/ 02/ 03
2144**3	1,50 m.	x 4		986 Kč/Ks	2144**2	1,50 m.	x 6		1.113 Kč/Ks
2145**3	1,80 m.	x 4		1.101 Kč/Ks	2145**2	1,80 m.	x 6		1.232 Kč/Ks
2146**3	2,10 m.	x 4		1.244 Kč/Ks	2146**2	2,10 m.	x 6		1.379 Kč/Ks
2147**3	2,40 m.	x 4		1.460 Kč/Ks	2147**2	2,40 m.	x 6		1.614 Kč/Ks
2148**3	3,00 m.	x 4		1.710 Kč/Ks	2148**2	3,00 m.	x 6		1.770 Kč/Ks

(s kroužky a koncovkami "Marbella")

Dřevo "EXTRA"

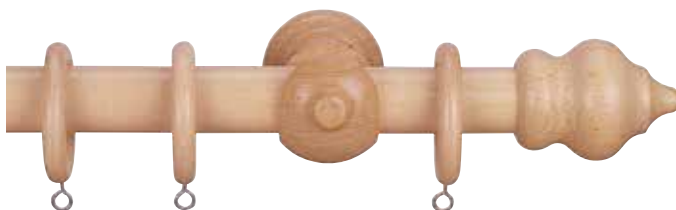

REF.	<---->			01/ 02/ 03	REF.	<---->			01/ 02/ 03
2154**3	1,50 m.	x 4		1.016 Kč/Ks	2154**2	1,50 m.	x 6		1.143 Kč/Ks
2155**3	1,80 m.	x 4		1.131 Kč/Ks	2155**2	1,80 m.	x 6		1.268 Kč/Ks
2156**3	2,10 m.	x 4		1.275 Kč/Ks	2156**2	2,10 m.	x 6		1.416 Kč/Ks
2157**3	2,40 m.	x 4		1.505 Kč/Ks	2157**2	2,40 m.	x 6		1.666 Kč/Ks
2158**3	3,00 m.	x 4		1.757 Kč/Ks	2158**2	3,00 m.	x 6		1.823 Kč/Ks

Leštěné držáky a kroužky, 35 mm

Kroužek s očkem⁽¹⁾ a Kroužek bez oka⁽²⁾

Kroužek "LISBOA"

Koncovka "MARBELLA"

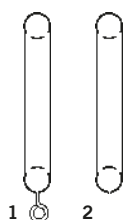

Ø Int. 53
Ø Ext. 75



1 2



Ø Int. 50
Ø Ext. 70



1931**0



Ø 60
70

0460**0

REF.	0302**0	0046**0	1931**0	0460**0
		x 275	x 275	x 50
	** 17 Kč/Ks	16 Kč/Ks	17 Kč/Ks	61 Kč/Ks

** Leštěné barvy: 01= vlašský ořech. 02= borovice. 03= teak. 04= dub. 05= kaštanová. 09= mahagon.
Kód obalu: 0= velikost. 2= blister. 3= zavírací obal.

Leštěné držáky a koncovky, 35 mm

Koncovka "GRANADA"



Koncovka "MÁLAGA"



Koncovka "MOTRIL"



REF. 1744**0



x 50



**

60 Kč/Ks

REF. 1711**0

x 50

54 Kč/Ks

REF. 1124**0

x 50

69 Kč/Ks

Koncovka "NERJA"



Koncovka "ALMERÍA"



Držák "MARBELLA"



REF. 1125**0



x 50

69 Kč/Ks

REF. 1776**0

x 50

37 Kč/Ks

REF. 0458**0

x 50

118 Kč/Ks

Stropní držák "MARBELLA"



Držák "GRANADA"



Držák "MALAGA"



REF. 0459**0



x 50

96 Kč/Ks

REF. 1743**0

x 50

102 Kč/Ks

REF. 1710**0

x 50

95 Kč/Ks

** Leštěné barvy: 01= vlašský ořech. 02= borovice. 03= teak. 04= dub. 05= kaštanová. 09= mahagon.
Kód obalu: 0= velikost.



BARVY



01.
vlašský ořech



02.
borovice



03.
teak



04.
dub



05.
kaštanová

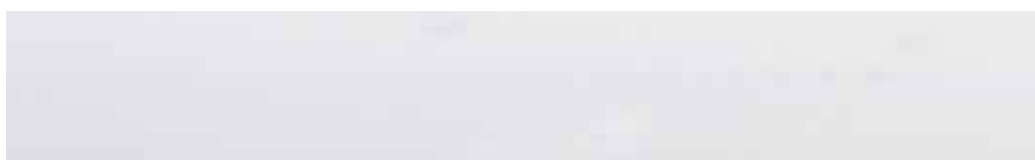

06.
bílá



07.
černá



09.
mahagon



10.
wenge



Novinka

79.
krémová

DŘEVO 28 mm.

Lakované dřevo 28 mm: (s kroužky a koncovkami "Chyc")

Dřevěná tyč "EXTRA"



REF.	←----→		A	B
0790**4	1,50 m.	x 5	793 Kč/Ks	912 Kč/Ks
0700**4	1,80 m.	x 5	869 Kč/Ks	999 Kč/Ks
0701**4	2,10 m.	x 5	967 Kč/Ks	1.112 Kč/Ks
0702**4	2,40 m.	x 5	1.117 Kč/Ks	1.284 Kč/Ks
0703**4	2,70 m.	x 5	1.212 Kč/Ks	1.393 Kč/Ks
0704**4	3,00 m.	x 5	1.282 Kč/Ks	1.474 Kč/Ks
0705**4	3,30 m.	x 5	1.387 Kč/Ks	1.596 Kč/Ks
0706**4	3,60 m. (2 tyče po 1,80 m)	x 5	1.464 Kč/Ks	1.683 Kč/Ks

REF.	←----→		A	B
0790**2	1,50 m.	x 6	912 Kč/Ks	1.049 Kč/Ks
0700**2	1,80 m.	x 6	1.007 Kč/Ks	1.158 Kč/Ks
0701**2	2,10 m.	x 6	1.113 Kč/Ks	1.279 Kč/Ks
0702**2	2,40 m.	x 6	1.291 Kč/Ks	1.485 Kč/Ks
-	-	-	-	-
0455**2	3,00 m. (2 tyče po 1,50 m)	x 6	1.416 Kč/Ks	1.628 Kč/Ks
-	-	-	-	-
0706**2	3,60 m. (2 tyče po 1,80 m)	x 6	1.606 Kč/Ks	1.847 Kč/Ks

POZNÁMKA: u tyčí delších jak 2,4 m jsou 3 držáky

Lakované dřevo 28 mm: (s kroužky a koncovkami "Lisboa")

Dřevěná tyč "EXTRA"



REF.	←----→		A
0780**4	1,50 m.	x 5	745 Kč/Ks
0781**4	1,80 m.	x 5	814 Kč/Ks
0782**4	2,10 m.	x 5	899 Kč/Ks
0783**4	2,40 m.	x 5	1.038 Kč/Ks
0750**4	2,70 m.	x 5	984 Kč/Ks
0784**4	3,00 m.	x 5	1.187 Kč/Ks
0752**4	3,60 m. (2 tyče po 1,80 m)	x 5	1.358 Kč/Ks

REF.	←----→		A
0780**2	1,50 m.	x 6	967 Kč/Ks
0781**2	1,80 m.	x 6	1.066 Kč/Ks
0782**2	2,10 m.	x 6	1.175 Kč/Ks
0783**2	2,40 m.	x 6	1.294 Kč/Ks
-	-	-	-
0784**2	3,00 m. (2 tyče po 1,50 m)	x 6	1.514 Kč/Ks
0752**2	3,60 m. (2 tyče po 1,80 m)	x 6	1.718 Kč/Ks

POZNÁMKA: u tyčí delších jak 2,4 m jsou 3 držáky

Lakované dřevo 28 mm: (kroužky, stropní držáky a koncovky "Chyc")

Dřevěná tyč "EXTRA"



REF.	←----→		A	B
0668**4	1,50 m.	x 5	774 Kč/Ks	891 Kč/Ks
0669**4	1,80 m.	x 5	853 Kč/Ks	981 Kč/Ks
0670**4	2,10 m.	x 5	951 Kč/Ks	1.094 Kč/Ks
0671**4	2,40 m.	x 5	1.092 Kč/Ks	1.255 Kč/Ks
0672**4	2,70 m.	x 5	1.187 Kč/Ks	1.364 Kč/Ks
0673**4	3,00 m.	x 5	1.258 Kč/Ks	1.447 Kč/Ks
0674**4	3,30 m.	x 5	1.360 Kč/Ks	1.564 Kč/Ks
0675**4	3,60 m. (2 tyče po 1,80 m)	x 5	1.436 Kč/Ks	1.651 Kč/Ks

POZNÁMKA: u tyčí delších jak 2,4 m jsou 3 držáky

** Barvy A: 01= vlašský ořech. 02= borovice. 03= teak. 04= dub. 05= kaštanová. 09= mahagon. 10= wenge

** Barvy B: 06= bílá. 07= černá. 79= krémová. (na objednávku)

Kód obalu: 2= blister. 4= ochranný obal.

Hladké dřevěné tyče 28 mm

Dřevo "EXTRA"

Dřevo "SAMBA"



REF.	←----→		A	B
2929**3	1,50 m.	x 20	249 Kč/Ks	285 Kč/Ks
2930**3	1,80 m.	x 20	299 Kč/Ks	345 Kč/Ks
2931**3	2,10 m.	x 20	348 Kč/Ks	400 Kč/Ks
2932**3	2,40 m.	x 20	388 Kč/Ks	447 Kč/Ks
2933**3	2,70 m.	x 20	453 Kč/Ks	521 Kč/Ks
2934**3	3,00 m.	x 20	483 Kč/Ks	555 Kč/Ks

REF.	←----→		A	B
1145**3	1,50 m.	x 20	171 Kč/Ks	205 Kč/Ks
1146**3	1,80 m.	x 20	206 Kč/Ks	248 Kč/Ks
1147**3	2,10 m.	x 20	243 Kč/Ks	291 Kč/Ks
1148**3	2,40 m.	x 20	266 Kč/Ks	319 Kč/Ks
1149**3	2,70 m.	x 20	297 Kč/Ks	357 Kč/Ks
1150**3	3,00 m.	x 20	329 Kč/Ks	394 Kč/Ks

Kroužky 28 mm

Kroužek s očkem

Kroužek bez očka

Kroužek s očkem



Ø Int. 40
Ø Ext. 60



Ø Int. 40
Ø Ext. 60



Ø Int. 37
Ø Ext. 55



REF.	0305**0	0319**0	0035**0	0362**2	0345**2
	x 400	x 400	x 400	x 10	x 10
A	12 Kč/Ks	-	10 Kč/Ks	201 Kč/bl.	-
B	-	19 Kč/Ks	-	-	228 Kč/bl.

Lesklý plastový kroužek bez očka

Kroužek "LISBOA"

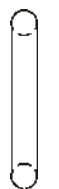

Ø Int. 37
Ø Ext. 55



Ø Int. 37
Ø Ext. 55



REF.	1445060	1941**0	1941**2
	x 400	x 400	x 10
A	-	12 Kč/Ks	204 Kč/bl.
B	9 Kč/Ks	15 Kč/Ks	224 Kč/bl.

** Barvy A: 01= vlašský ořech. 02= borovice. 03= teak. 04= dub. 05= kaštanová. 09= mahagon. 10= wenge
** Barvy B: 06= bílá. 07= černá. 79= krémová. (na objednávku)
Kód obalu: 0= velikost. 2= blister. 3= zavrácací obal.

Lakované držáky 28 mm

Držák otevřený "C"

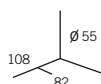

Držák otevřený dlouhý

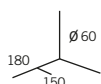

Držák otevřený dlouhý, příčně pruhovaný

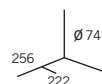

REF.	0376**0	0376**2	0377**0	0377**2	0442**0
	x 50	x 2	x 25	x 1	x 25
A	86 Kč/Ks	238 Kč/bl.	138 Kč/Ks	341 Kč/bl.	266 Kč/Ks
B	94 Kč/Ks	262 Kč/bl.	153 Kč/Ks	375 Kč/bl.	292 Kč/Ks

Dvoj držák otevřený 28-20

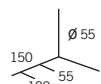

Dvoj držák otevřený 28-28

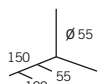

Držák otevřený

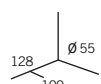

REF.	0086**0	0086**2	0082**0	0082**2	0111**0
	x 25	x 1	x 25	x 1	x 50
A	117 Kč/Ks	214 Kč/bl.	115 Kč/Ks	213 Kč/bl.	94 Kč/Ks
B	128 Kč/Ks	236 Kč/bl.	127 Kč/Ks	233 Kč/bl.	103 Kč/Ks

Držák "LISBOA"

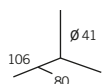

Dvoj držák otevřený 28-28 "LISBOA"

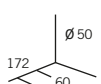

Držák posuvný

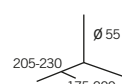

REF.	1767**0	1767**2	0308**0	0308**2	1474**0	1474**2
	x 50	x 2	x 25	x 1	x 25	x 1
A	78 Kč/Ks	192 Kč/bl.	90 Kč/Ks	143 Kč/bl.	118 Kč/Ks	189 Kč/bl.
B	87 Kč/Ks	212 Kč/bl.	99 Kč/Ks	159 Kč/bl.	130 Kč/Ks	207 Kč/bl.

** Bary A: 01= vlašský ořech. 02= borovice. 03= teak. 04= dub. 05= kaštanová. 09= mahagon. 10= wenge
 ** Bary B: 06= bílá. 07= černá. 79= krémová. (na objednávku)
 Kód obalu: 0= velikost. 2= blister.

Lakované držáky 28 mm

Držák koncovkový



Stropní držák special



Držák koncovkový "LISBOA"



REF.	1493**0	1493**2	1067**0	0310**0	0310**2
------	---------	---------	---------	---------	---------

	x 50	x 2	x 50	x 50	x 2
--	------	-----	------	------	-----

	A	60 Kč/Ks	183 Kč/bl.	58 Kč/Ks	45 Kč/Ks	143 Kč/bl.
	B	66 Kč/Ks	201 Kč/bl.	63 Kč/Ks	50 Kč/Ks	159 Kč/bl.

Rohový nástěnný držák
(pouze pro ref. 0376**0/0376**2)



Rohový nástěnný držák
(pouze pro ref. 0111**0)



Stropní držák



REF.	0240**0	0240**2	1465**0	0565**0	0565**2
------	---------	---------	---------	---------	---------

	x 25	x 1	x 25	x 50	x 2
--	------	-----	------	------	-----

	A	115 Kč/Ks	221 Kč/bl.	115 Kč/Ks	78 Kč/Ks	251 Kč/bl.
	B	126 Kč/Ks	244 Kč/bl.	126 Kč/Ks	87 Kč/Ks	276 Kč/bl.

Stropní držák rohový



Stropní držák "LISBOA"



Príslušenství k posuvnému držáku 28-20
(pro použití s držákem 1474**0/1474**2)



REF.	0292**0	0292**2	1343**0	1343**2	1475**0
------	---------	---------	---------	---------	---------

	x 50	x 1	x 50	x 2	x 25
--	------	-----	------	-----	------

	A	82 Kč/Ks	187 Kč/bl.	74 Kč/Ks	193 Kč/bl.	62 Kč/Ks
	B	90 Kč/Ks	205 Kč/bl.	82 Kč/Ks	213 Kč/bl.	68 Kč/Ks

** Barvy **A**: 01= vlašský ořech. 02= borovice. 03= teak. 04= dub. 05= kaštanová. 09= mahagon. 10= wenge

** Barvy **B**: 06= bílá. 07= černá. 79= krémová. (na objednávku)

Kód obalu: 0= velikost. 2= blister.

Lakované koncovky 28 mm

Koncovka "CHYC"



Koncovka "MOTRIL"



Koncovka "NERJA"



REF.	0033**0	0033**2	0309**0	0309**2	1332**0	1332**2
	x 50	x 2	x 50	x 1	x 50	x 1
A	60 Kč/Ks	228 Kč/bl.	60 Kč/Ks	115 Kč/bl.	51 Kč/Ks	131 Kč/bl.
B	66 Kč/Ks	251 Kč/bl.	66 Kč/Ks	127 Kč/bl.	56 Kč/Ks	144 Kč/bl.

Koncovka "LISBOA"



Koncovka "ESFERA"



Koncovka "ESFERA CON BOTÓN"



REF.	1614**0	1614**2	1479**0	1479**2	1466**0	1466**2
	x 50	x 2	x 50	x 2	x 50	x 2
A	50 Kč/Ks	156 Kč/bl.	44 Kč/Ks	142 Kč/bl.	46 Kč/Ks	186 Kč/bl.
B	54 Kč/Ks	171 Kč/bl.	48 Kč/Ks	156 Kč/bl.	51 Kč/Ks	204 Kč/bl.

Koncovka "ESPECIAL"



REF.	1469**0	1469**2
	x 50	x 2
A	38 Kč/Ks	177 Kč/bl.
B	42 Kč/Ks	195 Kč/bl.

** Barvy A: 01= vlašský ořech. 02= borovice. 03= teak. 04= dub. 05= kaštanová. 09= mahagon. 10= wenge
 ** Barvy B: 06= bílá. 07= černá. 79= krémová. (na objednávku)
 Kód obalu: 0= velikost. 2= blister.

Leštěné dřevo 28 mm

(s kroužky a koncovkami "Granada")

Dřevo "EXTRA"



REF.	<---->			01/ 02/ 03	REF.	<---->			01/ 02/ 03
2096**3	1,50 m.	x 5		756 Kč/Ks	2096**2	1,50 m.	x 6		844 Kč/Ks
2097**3	1,80 m.	x 5		849 Kč/Ks	2097**2	1,80 m.	x 6		934 Kč/Ks
2098**3	2,10 m.	x 5		964 Kč/Ks	2098**2	2,10 m.	x 6		1.040 Kč/Ks
2099**3	2,40 m.	x 5		1.121 Kč/Ks	2099**2	2,40 m.	x 6		1.206 Kč/Ks
2101**3	3,00 m.	x 5		1.339 Kč/Ks	2101**2	3,00 m.	x 6		1.335 Kč/Ks

(s kroužky a koncovkami "Marbella")

Dřevo "EXTRA"



REF.	<---->			01/ 02/ 03	REF.	<---->			01/ 02/ 03
2078**3	1,50 m.	x 5		813 Kč/Ks	2078**2	1,50 m.	x 6		898 Kč/Ks
2079**3	1,80 m.	x 5		905 Kč/Ks	2079**2	1,80 m.	x 6		989 Kč/Ks
2080**3	2,10 m.	x 5		1.020 Kč/Ks	2080**2	2,10 m.	x 6		1.095 Kč/Ks
2081**3	2,40 m.	x 5		1.194 Kč/Ks	2081**2	2,40 m.	x 6		1.278 Kč/Ks
2083**3	3,00 m.	x 5		1.408 Kč/Ks	2083**2	3,00 m.	x 6		1.403 Kč/Ks

Leštěné kroužky 28 mm

Kroužek s očkem⁽¹⁾ a Kroužek bez očka⁽²⁾

Kroužek "LISBOA"

Koncovka "MARBELLA"

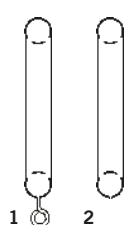

1
2

Ø Int. 40
Ø Ext. 60



1 2



Ø Int. 37
Ø Ext. 55



REF.	0305**0	0035**0	1941**0	1941**2	0663**0
	x 400	x 400	x 400	x 2	x 50
**	12 Kč/Ks	10 Kč/Ks	12 Kč/Ks	204 Kč/Ks	48 Kč/Ks

** Leštěné barvy: 01= vlašský ořech. 02= borovice. 03= teak. 04= dub. 05= kaštanová. 09= mahagon.
Kód obalu: 0= velikost. 2= blister. 3= zavírací obal.

Leštěné držáky a koncovky, 28 mm

Koncovka "GRANADA"



Koncovka "MALAGA"



Koncovka "MOTRIL"



REF. 1715**0



x 50

REF. 1717**0

x 50

REF. 1122**0

x 50



A

37 Kč/Ks

44 Kč/Ks

55 Kč/Ks

Koncovka "NERJA"



Koncovka "ALMERÍA"



Držák "MARBELLA"



REF. 1123**0



x 50

REF. 1777**0

x 50

REF. 0567**0

x 50



A

53 Kč/Ks

25 Kč/Ks

90 Kč/Ks

Držák "GRANADA"

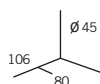

Držák "MÁLAGA"

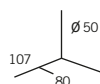

Stropní držák "MARBELLA"



REF. 1714**0



x 50

REF. 1716**0

x 50

REF. 0568**0

x 50



A

74 Kč/Ks

82 Kč/Ks

79 Kč/Ks

Montážní typy pro dvojtyč 28-28 mm

(vždy s držákem 0082**0 a jednoduchou koncovkou 1469**0)



Komponenty pro dvojtyč o 28-28

Dřevěné tyče extra 28+28	←--→	Kroužky 0305**0	Držáky 0082**0	Koncovky 0033**0+1469**0	€
2929**3 + 2929**3	1,50 m.	16+16	2	2+2	-
2930**3 + 2930**3	1,80 m.	18+18	2	2+2	-
2931**3 + 2931**3	2,10 m.	22+22	2	2+2	-
2932**3 + 2932**3	2,40 m.	24+24	3	2+2	-
2933**3 + 2933**3	2,70 m.	28+28	3	2+2	-
2934**3 + 2934**3	3,00 m.	30+30	3	2+2	-

Montážní typy pro dvojtyč 28-20 mm

(vždy s držákem 0086**0 a jednoduchou koncovkou 1484**0)



Komponenty pro dvojtyč o 28-20

Dřevěné tyče extra 28+20	←--→	Kroužky 0305**0+0290**0	Držáky 0086**0	Koncovky 0033**0+1484**0	€
2929**3 + 2936**3	1,50 m.	16+16	2	2+2	-
2930**3 + 2937**3	1,80 m.	18+18	3	2+2	-
2931**3 + 2938**3	2,10 m.	22+22	3	2+2	-
2932**3 + 2939**3	2,40 m.	24+24	3	2+2	-
2933**3 + 2962**3	2,70 m.	28+28	3	2+2	-
2934**3 + 2987**3	3,00 m.	30+30	3	2+2	-

Montážní typy pro dvojtyč 20-20 mm

(vždy s držákem 0076**0 a jednoduchou koncovkou 1484**0)



Komponenty pro dvojtyč o 20-20

Dřevěné tyče extra 20+20	←--→	Kroužky 0290**0	Držáky 0076**0	Koncovky 0570**0+1484**0	€
2936**3 + 2936**3	1,50 m.	16+16	2	2+2	-
2937**3 + 2937**3	1,80 m.	18+18	3	2+2	-
2938**3 + 2938**3	2,10 m.	22+22	3	2+2	-
2939**3 + 2939**3	2,40 m.	24+24	3	2+2	-
2962**3 + 2962**3	2,70 m.	28+28	3	2+2	-
2987**3 + 2987**3	3,00 m.	30+30	3	2+2	-

** Barvy: 01= vlašský ořech. 02= borovice. 03= teak. 04= dub. 05= kaštanová. 09= mahagon.
Kód obalu: 3= zavírací obal.

BARVY



01. vlašský ořech



06. bílá



02. borovice



07. černá



03. teak



09. mahagon



04. dub



10. wenge



05. kaštanová



79. krémová

Novinka

Lakované dřevo 20 mm: (s kroužky a koncovkami "Chyc")

Dřevěná tyč "EXTRA"



REF.	<---->		A	B
0772**4	1,20 m.	x 10	442 Kč/Ks	508 Kč/Ks
0773**4	1,50 m.	x 10	497 Kč/Ks	572 Kč/Ks
0774**4	1,80 m.	x 10	594 Kč/Ks	683 Kč/Ks
0775**4	2,10 m.	x 10	650 Kč/Ks	747 Kč/Ks
0776**4	2,40 m.	x 10	693 Kč/Ks	797 Kč/Ks
0777**4	2,70 m.	x 10	744 Kč/Ks	856 Kč/Ks
0778**4	3,00 m.	x 10	796 Kč/Ks	915 Kč/Ks



REF.	<---->		A	B
0772**2	1,20 m.	x 6	564 Kč/Ks	648 Kč/Ks
0773**2	1,50 m.	x 6	633 Kč/Ks	727 Kč/Ks
0774**2	1,80 m.	x 6	752 Kč/Ks	865 Kč/Ks
0775**2	2,10 m.	x 6	826 Kč/Ks	950 Kč/Ks
0776**2	2,40 m.	x 6	898 Kč/Ks	1.032 Kč/Ks
-	-	-	-	-
-	-	-	-	-

POZNÁMKA: u tyčí delších jak 1,8 m jsou 3 držáky

** Barvy A: 01= vlašský ořech. 02= borovice. 03= teak. 04= dub. 05= kaštanová. 09= mahagon. 10= wenge

** Barvy B: 06= bílá. 07= černá. 79= krémová. (na objednávku)

Kód obalu: 2= blister. 4= ochranný obal.

Hladké dřevěné tyče 20 mm

Dřevo "EXTRA"



REF.	←----→		A	B
2935**3	1,20 m.	x 36	123 Kč/Ks	141 Kč/Ks
2936**3	1,50 m.	x 36	153 Kč/Ks	176 Kč/Ks
2937**3	1,80 m.	x 36	186 Kč/Ks	214 Kč/Ks
2938**3	2,10 m.	x 36	215 Kč/Ks	248 Kč/Ks
2939**3	2,40 m.	x 36	245 Kč/Ks	282 Kč/Ks
2962**3	2,70 m.	x 36	276 Kč/Ks	316 Kč/Ks
2987**3	3,00 m.	x 36	304 Kč/Ks	351 Kč/Ks

Lesklý plastový kroužek bez očka



∅ Int. 25
∅ Ext. 50

REF.	1451060	1451062
------	---------	---------

x 50

x 10

B	6 Kč/Ks	137 Kč/Ks
---	---------	-----------

Lakované kroužky a koncovky, 20 mm

Kroužek bez očka

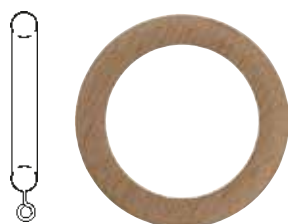

∅ Int. 29
∅ Ext. 45

Kroužek s očkem

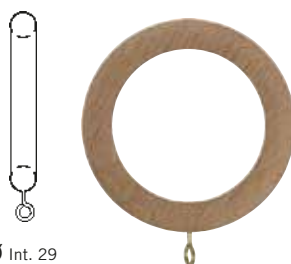

∅ Int. 29
∅ Ext. 45

Kroužek s očkem



∅ Int. 29
∅ Ext. 45

REF.	0115**0	0290**0	0290**2	0210060	0210062
	x 700	x 700	x 10	x 700	x 10
A	6 Kč/Ks	7 Kč/Ks	168 Kč/bl.	-	-
B	-	-	-	12 Kč/Ks	108 Kč/bl.

Koncovka "CHYC"



∅ 42
65

Koncovka "ESFERA"



∅ 40
37

Koncovka "ESPECIAL"



∅ 34
19

REF.	0570**0	0570**2	1478**0	1478**2	1484**0	1484**2
	x 50	x 2	x 50	x 2	x 50	x 2
A	38 Kč/Ks	185 Kč/bl.	31 Kč/Ks	138 Kč/bl.	38 Kč/Ks	171 Kč/bl.
B	42 Kč/Ks	203 Kč/bl.	34 Kč/Ks	153 Kč/bl.	42 Kč/Ks	188 Kč/bl.

** Barvy A: 01= vlašský ořech. 02= borovice. 03= teak. 04= dub. 05= kaštanová. 09= mahagon. 10= wenge

** Barvy B: 06= bílá. 07= černá. 79= krémová. (na objednávku)

Kód obalu: 0= velikost. 2= blister. 3= závěrací obal.

Lakované doplňky a držáky, 20 mm

Rozeta



Držák otevřený

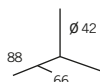

Dvoj držák otevřený 20-20



REF.	1457**0	1457**2	0074**0	0074**2	0076**0	0076**2
	x 50	x 1	x 50	x 2	x 25	x 1
A	58 Kč/Ks	162 Kč/bl.	68 Kč/Ks	220 Kč/bl.	83 Kč/Ks	175 Kč/bl.
B	63 Kč/Ks	179 Kč/bl.	75 Kč/Ks	242 Kč/bl.	91 Kč/Ks	193 Kč/bl.

Držák posuvný

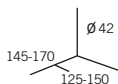

Držák koncovkový



Rohový nástěnný držák

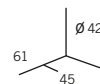

REF.	1461**0	1461**2	1701**0	1701**2	1454**0	1454**2
	x 25	x 1	x 50	x 1	x 50	x 1
A	91 Kč/Ks	156 Kč/bl.	45 Kč/Ks	168 Kč/bl.	60 Kč/Ks	162 Kč/bl.
B	100 Kč/Ks	171 Kč/bl.	50 Kč/Ks	185 Kč/bl.	66 Kč/Ks	179 Kč/bl.

Stropní držák



Stropní držák rohový



Držák koncovkový

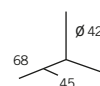

REF.	0664**0	0664**2	1455**0	1455**2	1456**0	1456**2
	x 50	x 2	x 50	x 1	x 50	x 2
A	56 Kč/Ks	220 Kč/bl.	63 Kč/Ks	168 Kč/bl.	56 Kč/Ks	219 Kč/bl.
B	62 Kč/Ks	242 Kč/bl.	69 Kč/Ks	185 Kč/bl.	62 Kč/Ks	240 Kč/bl.

** Barvy A: 01= vlašský ořech. 02= borovice. 03= teak. 04= dub. 05= kaštanová. 09= mahagon. 10= wenge
 ** Barvy B: 06= bílá. 07= černá. 79= krémová. (na objednávku)
 Kód obalu: 0= velikost. 2= blister.

Leštěné dřevo, 20 mm

(s kroužky a koncovkami "Granada")

Dřevo "EXTRA"



REF.	←----→			01/ 02/ 03	REF.	←----→			01/ 02/ 03
2268**3	1,20 m.	x 10		441 Kč/Ks	2268**2	1,20 m.	x 6		530 Kč/Ks
2269**3	1,50 m.	x 10		511 Kč/Ks	2269**2	1,50 m.	x 6		602 Kč/Ks
2270**3	1,80 m.	x 10		620 Kč/Ks	2270**2	1,80 m.	x 6		713 Kč/Ks
2271**3	2,10 m.	x 10		694 Kč/Ks	2271**2	2,10 m.	x 6		789 Kč/Ks
2272**3	2,40 m.	x 10		756 Kč/Ks	2272**2	2,40 m.	x 6		858 Kč/Ks

Leštěné kroužky, držáky a koncovky, 20 mm

Kroužek s očkem



∅ Int. 29
∅ Ext. 45

Kroužek bez očka

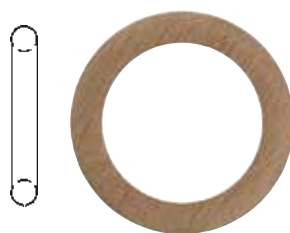

∅ Int. 29
∅ Ext. 45

Koncovka "GRANADA"

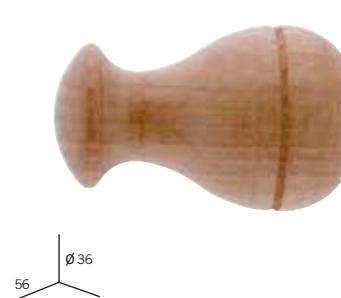

∅ 36
56

REF.	0290**0	0290**2	0115**0	1741**0
	x 700		x 700	
				x 50
	** 7 Kč/Ks	168 Kč/bl.	6 Kč/Ks	30 Kč/Ks

Koncovka "MÁLAGA"



∅ 36
52

Držák "GRANADA"



∅ 36
80
60

Držák "MÁLAGA"



∅ 36
79
60

REF.	1742**0	1745**0	1740**0
	x 50	x 50	x 50
	** 30 Kč/Ks	53 Kč/Ks	53 Kč/Ks

** Leštěné barvy: 01= vlašský ořech. 02= borovice. 03= teak. 04= dub. 05= kaštanová. 09= mahagon.
Kód obalu: 0= velikost. 2= blister. 3= zavírací obal.

BARVY



01. vlašský ořech



03. teak



02. borovice

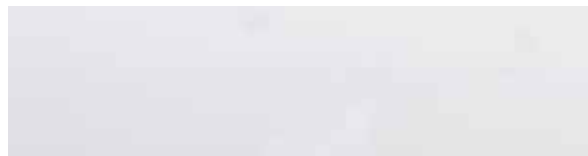

06. bílá

Lakované dřevo 12 mm: (s kroužky a koncovkami "Chyc")

Dřevěná tyč "EXTRA"



REF.	<---->		A	B
-	-	-	-	-
1318**4	0,90 m.	x 20	280 Kč/Ks	322 Kč/Ks
1319**4	1,20 m.	x 20	302 Kč/Ks	348 Kč/Ks
1320**4	1,50m.	x 20	381 Kč/Ks	439 Kč/Ks
1321**4	1,80 m.	x 20	399 Kč/Ks	459 Kč/Ks



REF.	<---->		A	B
2750**2	0,60 m.	x 6	318 Kč/Ks	366 Kč/Ks
1318**2	0,90 m.	x 6	371 Kč/Ks	426 Kč/Ks
1319**2	1,20 m.	x 6	406 Kč/Ks	467 Kč/Ks
1320**2	1,50 m.	x 6	506 Kč/Ks	582 Kč/Ks
-	-	-	-	-

POZNÁMKA: u tyčí delších jak 1,5 m jsou 3 držáky

Hladké dřevěné tyče 12 mm

Dřevo "EXTRA"



REF.	<---->		A	B
1914**3	0,90 m.	x 100	48 Kč/Ks	58 Kč/Ks
1915**3	1,20 m.	x 100	62 Kč/Ks	74 Kč/Ks
1916**3	1,50 m.	x 100	86 Kč/Ks	102 Kč/Ks
1917**3	1,80 m.	x 100	91 Kč/Ks	108 Kč/Ks
1976**3	2,10 m.	x 100	106 Kč/Ks	127 Kč/Ks
1977**3	2,40 m.	x 100	118 Kč/Ks	141 Kč/Ks

** Barvy A: 01= vlašský ořech. 02= borovice. 03= teak.

** Barvy B: 06= bílá.

Kód obalu: 2= blister. 3= zavírací obal. 4= ochranný obal.

Lakované kroužky, držáky a koncovky, 12 mm

Kroužek s očkem



Ø Int. 21
Ø Ext. 35

Kroužek bez očka

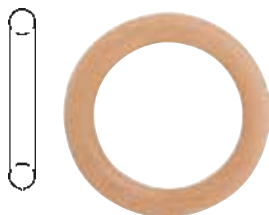

Ø Int. 21
Ø Ext. 35

Kroužek s očkem



Ø Int. 21
Ø Ext. 35

REF. **0209**0** **0209**2** **0116**0** **0561060** **0561062**

x 1400

x 10

x 1400

x 1400

x 10

A **6 Kč/Ks** **153 Kč/bl.**

B - -

4 Kč/Ks

-

9 Kč/Ks

178 Kč/bl.

Lesklý plastový kroužek bez očka



Ø Int. 19
Ø Ext. 31

Koncovka "CHYC"



Ø 30
40

Držák otevřený



Ø 30
50
32

REF. **0361060** **0072**0** **0072**2** **0070**0** **0070**2**

x 100

x 50

x 2

x 50

x 2

A -

B **3 Kč/Ks**

25 Kč/Ks **144 Kč/bl.**

27 Kč/Ks **159 Kč/bl.**

41 Kč/Ks **186 Kč/bl.**

44 Kč/Ks **204 Kč/bl.**

Dvoj držák otevřený 12-12



Ø 42
118
45
95

Držák koncovkový



Ø 30
21

Držák posuvný



Ø 42
138-163
120-145

REF. **1471**0** **1471**2** **1463**0** **1463**2** **1494**0** **1494**2**

x 25

x 1

x 50

x 2

x 25

x 1

A **108 Kč/Ks** **203 Kč/bl.**

B **120 Kč/Ks** **223 Kč/bl.**

35 Kč/Ks **172 Kč/bl.**

39 Kč/Ks **189 Kč/bl.**

88 Kč/Ks **180 Kč/bl.**

96 Kč/Ks **197 Kč/bl.**

** Bary A: 01= vlašský ořech. 02= borovice. 03= teak.

** Bary B: 06= bílá.

Kód obalu: 0= velikost. 2= blister.

Lakované držáky 12 mm

Držák uzavřený

Držák koncovkový

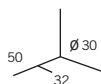
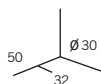

REF.	1460**0	1460**2	1458**0	1458**2
------	---------	---------	---------	---------

x 50

x 2

x 50

x 2



A	29 Kč/Ks	162 Kč/bl.	28 Kč/Ks	162 Kč/bl.
B	32 Kč/Ks	179 Kč/bl.	31 Kč/Ks	178 Kč/bl.

Leštěné kroužky, držáky a koncovky, 12 mm

Kroužek s očkem

Kroužek bez očka

Koncovka "GRANADA"

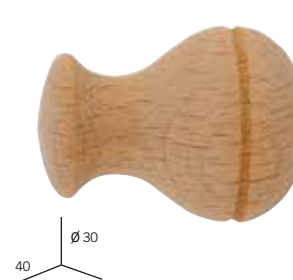
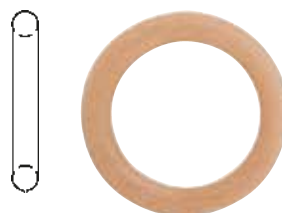
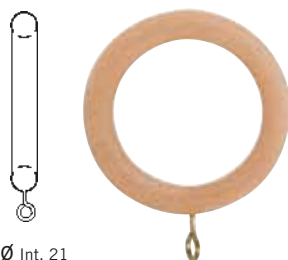

Ø Int. 21
Ø Ext. 35

Ø Int. 21
Ø Ext. 35

Ø 30
40

REF.	0209**0	0209**2	0116**0	1438**0
------	---------	---------	---------	---------

x 1400

x 10

x 1400

x 50



A	6 Kč/Ks	153 Kč/bl.	4 Kč/Ks	22 Kč/Ks
---	---------	------------	---------	----------

Držák uzavřený "GRANADA"

Držák koncovkový "GRANADA"

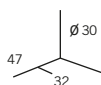
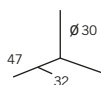

REF.	1436**0	1399**0
------	---------	---------

x 50

x 50



A	29 Kč/Ks	27 Kč/Ks
---	----------	----------

** Barvy A: 01= vlašský ořech. 02= borovice. 03= teak.

** Barvy B: 06= bílá.

Kód obalu: 0= velikost. 2= blister.

Popotahovací tyče a rozety

Popotahovací tyč 0,75 m s karabinou



Popotahovací tyč 1,00 m s karabinou



Popotahovací tyč 0,75 m s háčkem



REF.	0198**0	0698**0	0698**2	0543**0
	x 35	x 35	x 1	x 35
A	84 Kč/Ks	94 Kč/Ks	133 Kč/bl.	86 Kč/Ks
B	93 Kč/Ks	103 Kč/Ks	146 Kč/bl.	94 Kč/Ks

Popotahovací tyč 1,00 m s háčkem



Rozeta



Ozdobná žabka na kroužek



REF.	0284**0	0056**0	0056**2	0352440	0352442 (1)
	x 35	x 50	x 1	x 100	x 6
A	95 Kč/Ks	137 Kč/Ks	198 Kč/bl.	BARVY ZINKOVÁ	8 Kč/Ks
B	104 Kč/Ks	151 Kč/Ks	219 Kč/bl.		74 Kč/bl.

(1) Do vyprodání zásob

Příslušenství

Výstuha tyče 35

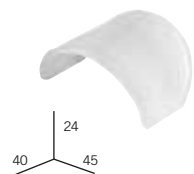

Výstuha tyče 28

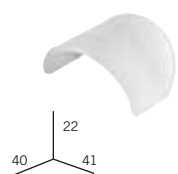

Výstuha tyče 20

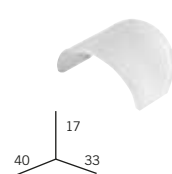

Výstuha tyče 12

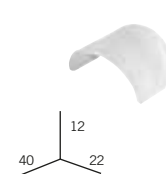

REF.	2550200	2550202	2549200	2549202	2927200	2927202	2928200	2928202
	x 50	x 10	x 50	x 10	x 50	x 10	x 50	x 10
A	20 Kč/Ks	212 Kč/bl.	19 Kč/Ks	200 Kč/bl.	18 Kč/Ks	192 Kč/bl.	13 Kč/Ks	160 Kč/bl.

** Barvy A: 01= vlašský ořech. 02= borovice. 03= teak. 04= dub. 05= kaštanová. 09= mahagon. 10= Wenge. / 20= průhledná.

** Barvy B: 06= bílá. 07= černá. 79= krémová. (na objednávku)

Kód obalu: 0= velikost. 2= blister.

Příslušenství

Fixační šrouby k montáži držáku 35-28 mm

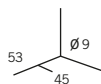

REF. **0049440**

x 25

44 **108 Kč/balení**

Fixační šrouby k montáži držáku 20 mm

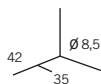

REF. **0073440**

x 25

75 Kč/balení

Šroub pro montáž koncovek 50 mm

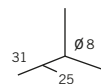

REF. **1470440**

x 25

106 Kč/balení

Fixační šrouby k montáži držáku 12 mm

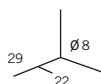

REF. **1486440**

x 25

A **91 Kč/balení**

Šroub pro montáž držáků - mini

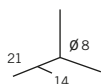

REF. **1459440**

x 25

74 Kč/krabice.

Spojovací šroub pro dřevěné tyče

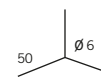

REF. **1450440**

x 25

123 Kč/krabice.

REF. **1450442**

x 2

29 Kč/bl.

Koncový pojezd (pravý/levý)

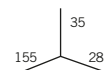

REF. **0439**0**

x 25

01 **640 Kč/krabice.**
02 **640 Kč/krabice.**
03 **640 Kč/krabice.**

Háček v imitaci dřeva 35-28 mm

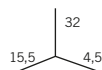

REF. **0173**0**

x 100

102 Kč/krabice.
102 Kč/krabice.
102 Kč/krabice.

Háček v imitaci dřeva 20-12 mm



REF. **0566**0**

x 100

81 Kč/krabice.
81 Kč/krabice.
81 Kč/krabice.

Háček 35-28 mm



REF. **1464**0**

x 100

01 **274 Kč/krabice.**
20 **388 Kč/krabice.**

REF. **1464**2**

x 10

51 Kč/bl.
51 Kč/bl.

Kovová destička 50 a 35 mm



REF. **0170440**

x 25

44 **456 Kč/krabice.**

REF. **0170442**

x 2

80 Kč/bl.

Kovová destička 28 mm



REF. **0150440**

x 25

438 Kč/krabice.

REF. **0150442**

x 2

74 Kč/bl.

** Barvy: 01= vlašský ořech. 02= borovice. 03= teak. 20= průhledná. 40= stříbrná. 44= zlatá.
Kód obalu: 0= velikost. 2= blister.

collection
PANEL JAPONÉS



Japonská stěna na míru

tažný systém se šňůrou/bez šňůry/bez šňůry - tažný nebo volný systém(stropní úchyt)

Poznámka:

1. Pokud zákazník žádá jinou velikost než-li je uvedena, cena vždy platí za nejbližší stoupající délku.
2. Řetízový systém lze objednat na pravo i na levo, pokud si zákazník přeje mít řetězky na obou stranách cena je navýšena o 10%.



Profil 2 kolejničky

<---->		tažný systém se šňůrou	bez šňůry	bez šňůry-tažný nebo volný systém	06	40
1,50 m.	x 1	7014060	7038060	7062060	1.671 Kč/Ks	-
2,00 m.	x 1	7015060	7039060	7063060	2.031 Kč/Ks	-
2,50 m.	x 1	7016060	7040060	7064060	2.393 Kč/Ks	-
3,00 m.	x 1	7017060	7041060	7065060	2.742 Kč/Ks	-
3,50 m.	x 1	7018060	7042060	7066060	3.238 Kč/Ks	-
4,00 m.	x 1	7019060	7043060	7067060	3.457 Kč/Ks	-

PŘÍSLUŠENSTVÍ:

Profil 2 kolejničky: doraz 2-kanálový (1pár), posuvný panel (x m), držák pojezdový (2 x), posunovač "L" (1 ks), posunovač "T" (1 ks), krátký stropní držák (1 na každých 60-70 cm), jezdec pro šňůru (1 ks), pevná koncovka - zátka (1 ks), suchý zip "L" (x m), hliníková spodní (zátěžová) lišta 40x3 (x m), zátky ke spodní liště (x m), protizávaží 70 gr. (1 ks).

Profil 3 kolejničky

<---->		tažný systém se šňůrou	bez šňůry	bez šňůry-tažný nebo volný systém	06	40
1,50 m.	x 1	7020**0	7044**0	7068**0	1.963 Kč/Ks	2.030 Kč/Ks
2,00 m.	x 1	7021**0	7045**0	7069**0	2.377 Kč/Ks	2.449 Kč/Ks
2,50 m.	x 1	7022**0	7046**0	7070**0	2.832 Kč/Ks	3.898 Kč/Ks
3,00 m.	x 1	7023**0	7047**0	7071**0	3.240 Kč/Ks	3.300 Kč/Ks
3,50 m.	x 1	7024**0	7048**0	7072**0	3.874 Kč/Ks	3.997 Kč/Ks
4,00 m.	x 1	7025**0	7049**0	7073**0	4.056 Kč/Ks	4.176 Kč/Ks

PŘÍSLUŠENSTVÍ:

Profil 3 kolejničky: doraz 3-kanálový (1pár), posuvný panel (x m), Držák pojezdový (2 x), posunovač "L" (2 ks), posunovač "T" (2 ks), krátký stropní držák (1 na každých 60-70 cm), jezdec pro šňůru (1 ks), pevná koncovka - zátka (1 ks), suchý zip "L" (x m), hliníková spodní (zátěžová) lišta 40x3 (x m), zátky ke spodní liště (x m), protizávaží 70 gr. (1 ks).

Profil 4 kolejničky

<---->		tažný systém se šňůrou	bez šňůry	bez šňůry-tažný nebo volný systém	06	40
1,50 m.	x 1	7026**0	7050**0	7074**0	2.267 Kč/Ks	2.357 Kč/Ks
2,00 m.	x 1	7027**0	7051**0	7075**0	2.761 Kč/Ks	2.898 Kč/Ks
2,50 m.	x 1	7028**0	7052**0	7076**0	3.260 Kč/Ks	3.408 Kč/Ks
3,00 m.	x 1	7029**0	7053**0	7077**0	3.746 Kč/Ks	3.978 Kč/Ks
3,50 m.	x 1	7030**0	7054**0	7078**0	4.471 Kč/Ks	4.668 Kč/Ks
4,00 m.	x 1	7031**0	7055**0	7079**0	4.725 Kč/Ks	5.532 Kč/Ks
4,50 m.	x 1	7094**0	7102**0	7086**0	5.107 Kč/Ks	5.481 Kč/Ks
5,00 m.	x 1	7095**0	7103**0	7087**0	5.583 Kč/Ks	5.933 Kč/Ks
5,50 m.	x 1	7096**0	7104**0	7088**0	6.069 Kč/Ks	6.370 Kč/Ks
6,00 m.	x 1	7097**0	7105**0	7089**0	6.547 Kč/Ks	6.784 Kč/Ks

PŘÍSLUŠENSTVÍ:

Profil 4 kolejničky: doraz 4-kanálový (1pár), posuvný panel (x m), držák pojezdový (2 x), posunovač "L" (3 ks), posunovač "T" (3 ks), dlouhý stropní držák (1 na každých 60-70 cm), jezdec pro šňůru (1 ks), pevná koncovka - zátka (1 ks), suchý zip "L" (x m), hliníková spodní (zátěžová) lišta 40x3 (x m), zátky ke spodní liště (x m), protizávaží 70 gr. (1 ks).

Profil 5 kolejniček

<---->		tažný systém se šňůrou	bez šňůry	bez šňůry-tažný nebo volný systém	06	40
1,50 m.	x 1	7032**0	7056**0	7080**0	2.520 Kč/Ks	2.684 Kč/Ks
2,00 m.	x 1	7033**0	7057**0	7081**0	3.034 Kč/Ks	3.138 Kč/Ks
2,50 m.	x 1	7034**0	7058**0	7082**0	3.579 Kč/Ks	3.817 Kč/Ks
3,00 m.	x 1	7035**0	7059**0	7083**0	4.123 Kč/Ks	4.263 Kč/Ks
3,50 m.	x 1	7036**0	7060**0	7084**0	4.956 Kč/Ks	5.315 Kč/Ks
4,00 m.	x 1	7037**0	7061**0	7085**0	5.194 Kč/Ks	5.532 Kč/Ks
4,50 m.	x 1	7098**0	7106**0	7090**0	5.601 Kč/Ks	5.934 Kč/Ks
5,00 m.	x 1	7099**0	7107**0	7091**0	6.123 Kč/Ks	6.509 Kč/Ks
5,50 m.	x 1	7100**0	7108**0	7092**0	6.622 Kč/Ks	7.039 Kč/Ks
6,00 m.	x 1	7101**0	7109**0	7093**0	7.172 Kč/Ks	7.419 Kč/Ks

PŘÍSLUŠENSTVÍ:

Profil 5 kolejniček: doraz 5-kanálový (1pár), posuvný panel (x m), držák pojezdový (2 x), posunovač "L" (4 ks), posunovač "T" (4 ks), dlouhý stropní držák (1 na každých 60-70 cm), jezdec pro šňůru (1 ks), pevná koncovka - zátka (1 ks), suchý zip "L" (x m), hliníková spodní (zátěžová) lišta 40x3 (x m), zátky ke spodní liště (x m), protizávaží 70 gr. (1 ks).

**Barvy A: 06= bílá, 40= stříbrná.
Kód obalu: 0= velikost.

Japonská stěna v blistru

3 kanálový/ 1,70 m.

4 kanálový/ 2,25 m.

5 kanálový/ 2,80 m.

REF.	7136062	7137062	7138062
	x 2	x 2	x 2
06	2.399 Kč/bl.	3.433 Kč/bl.	3.828 Kč/bl.

PŘÍSLUŠENSTVÍ:

Profil (3,4 a 5 kanálový): Dorazy, posuvné panely, koncovky (zátky), pojezdové drážky, posunovače "L" a "T", stropní drážky, drážky do stěny, šrouby a hmoždinky, jezdec pro šňůru, pevná koncovka - zátka, šňůra, hliníkové spodní (zátěžové) lišty 40x3, zátky ke spodní liště, protizávaží 70 gr., a spojka (pouze pro 5-ti kolejnici).

Profily pro japonské stěny

Profil 5-kanálový

Profil 4-kanálový



REF.	<--->		06	40
0932**0	6 m.	x 10	3.559 Kč/Ks	3.868 Kč/Ks
0939**0	4 m.	x 10	2.401 Kč/Ks	2.594 Kč/Ks

REF.	<--->		06	40
0931**0	6 m.	x 12	3.006 Kč/Ks	3.225 Kč/Ks
0938**0	4 m.	x 12	2.032 Kč/Ks	2.194 Kč/Ks

Profil 3-kanálový

Profil 2-kanálový

Posuvný panel se suchým zipem



REF.	<--->	06	40
		x 12	x 12
0930**0	6 m.	2.333 Kč/Ks	2.433 Kč/Ks
0937**0	4 m.	1.588 Kč/Ks	1.716 Kč/Ks

REF.	<--->	06	40
		x 12	x 12
0929060	6 m.	2.219 Kč/Ks	-
0936060	4 m.	1.484 Kč/Ks	-

REF.	<--->	06	40
		x 20	x 20
0928**0	6 m.	1.203 Kč/Ks	1.310 Kč/Ks
0940**0	4 m.	812 Kč/Ks	895 Kč/Ks

**Barvy A: 06= bílá. 40= stříbrná.
Kód obalu: 0= velikost. 2= blister.

Příslušenství pro japonské stěny

Pojezdový držák

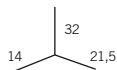

Koncovka - zátka

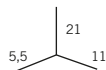

Doraz pro volný systém (pravý/levý)

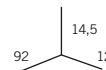

REF.	0959**0	0941**0	0922**0
	x 100	x 50	x 10
	06 4 Kč/Ks 32 4 Kč/Ks	47 Kč/krabice. 47 Kč/krabice.	41 Kč/Ks 41 Kč/Ks

Doraz 2-kanálový (pravý/levý)

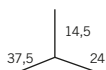

Doraz 3-kanálový (pravý/levý)

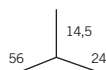

Doraz 4-kanálový (pravý/levý)

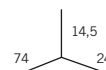

REF.	0918060	0919**0	0920**0
	10	x 10	x 10
	06 22 Kč/Ks 32 -	28 Kč/Ks 28 Kč/Ks	41 Kč/Ks 41 Kč/Ks

Doraz 5-kanálový (pravý/levý)

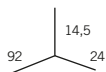

Krátký třímen (držák), pro 2-3 kanály, pevný

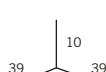

Dlouhý třímen (držák), pro 4-5 kanálů, pevný

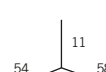

REF.	0921**0	0925400	0927400
	x 10	x 25	x 25
	06 47 Kč/Ks 32 47 Kč/Ks	10 Kč/Ks -	11 Kč/Ks -

**Barvy: 06= bílá, 32= šedá, 40= stříbrná.
Kód obalu: 0= velikost.

Příslušenství pro japonské stěny

Krátký třmen (držák), pro 2-3 kanály, nastavitelný

Dlouhý třmen (držák), pro 4-5 kanálů, nastavitelný

Stropní držák automatik, pro 2-3 kanálů

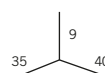
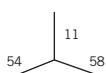
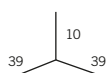

Novinka

REF.	0948400	0949400	7474060
	x 25	x 25	Krabice x 25
	06 - 40 17 Kč/Ks	- 18 Kč/Ks	31 Kč/Ks -

Stropní držák automatik, pro 4-5 kanálů

Posunovač

Zarážka

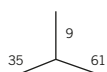

Novinka

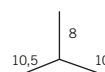
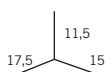

REF.	7475060	0923**0	0917400
	x 25	x 50	x 100
	06 31 Kč/Ks 32 - 40 -	6 Kč/Ks 6 Kč/Ks -	- - 9 Kč/Ks

Posunovač konečný

Posunovač pro tažný systém bez šňůry

Jezdec pro šňůru

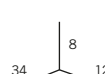
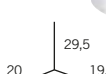
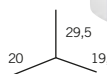

REF.	0924**0	0935**0	0916**0
	x 50	x 50	x 25
	06 6 Kč/Ks 32 6 Kč/Ks	10 Kč/Ks 10 Kč/Ks	6 Kč/Ks 6 Kč/Ks

**Barvy: 06= bílá, 32= šedá, 40= stříbrná.
Kód obalu: 0= velikost.

Příslušenství pro japonské stěny

Šňůra (polyester) Ø3



Spojka k 2 a 3 kanálovému profilu

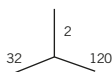

Spojka k 4 a 5 kanálovému profilu

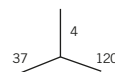

REF.	2553**0	0966400	0983400
	Návin x 200 m.	x 10	x 10
06	1.184 Kč/Návin.	-	-
32	865 Kč/Návin	-	-
40	-	53 Kč/Ks	54 Kč/Ks

Závaží 70 gr.

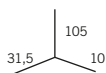

Podložka (pro upevnění třmenu)



Suchý zip s vyšším chlupem (1)



REF.	1204**0	1863060	0991**0
	x 10	x 50	Návin x 25 m.
06	37 Kč/Ks	90 Kč/krabice.	19 Kč/m.
07	-	-	19 Kč/m.
32	53 Kč/Ks	-	18 Kč/m.

Suchý zip klasik (1)



Hliníková spodní (zátěžová) lišta 24,5 mm. x 6 m.

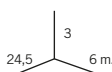

Hliníková spodní (zátěžová) lišta 24,5 mm. x 4 m.

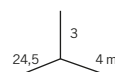

Minimální objednávka 250 m.

REF.	1698060	1075060	7274060
	Návin x 25 m.	x 50	x 50
06	13 Kč/m.	819 Kč/Ks	555 Kč/Ks

(1): Páska Loop je pro kombinaci s páskou Hook. Páska Velur je pro kombinaci s páskou Setax. Všechny profily Chyc jsou s lepším povrchem a jdou s páskou Hook. Páska Velur se může dát dohromady s páskou Hook, ale páska Loop se nemůže kombinovat s páskou Setax.

**Barvy: 06= bílá, 07= černá, 32= šedá, 40= stříbrná.
Kód obalu: 0= velikost.

Příslušenství pro japonské stěny

Hliníková spodní (zátěžová) lišta
24,5 mm. x 3 m.

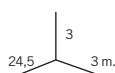

Hliníková spodní (zátěžová) lišta
40 mm. x 6 m.

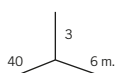

Hliníková spodní (zátěžová) lišta
40mm. x 4 m.

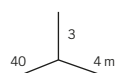

REF. **7300060**

REF. **1079060**

REF. **1100060**



x 50

x 50

x 50



06

427 Kč/Ks

1.323 Kč/Ks

878 Kč/Ks

Transparentní (průsvitná) zátěžová lišta
25 mm. x 3 m.

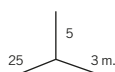

Transparentní (průsvitná) zátěžová lišta
40 mm. x 3 m.

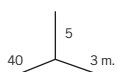

Polyesterová zátěžová lišta
30 mm. x 4 m.

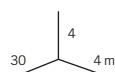

REF. **7344200**

REF. **7346200**

REF. **0828060**



x 50

x 50

x 50



06

-
629 Kč/Ks

-
783 Kč/Ks

457 Kč/Ks
-

Uzávěr lišty 40 x 3 mm.

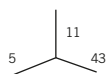

Uzávěr lišty 25 x 3 mm.

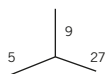

Zesílený držák 9-12 cm

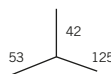

REF. **1779200**

REF. **1772200**

REF. **1817060**



x 50

x 50

x 20



06

-
9 Kč/Ks

-
6 Kč/Ks

32 Kč/Ks
-

**Barvy: 06= bílá, 40= stříbrná.
Kód obalu: 0= velikost.

Příslušenství pro japonské stěny

Hliníkový držák 10 cm.

Hliníkový držák 15 cm.

Hliníkový držák 19 cm.

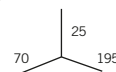
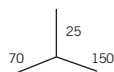
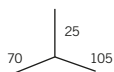

REF.	7199060	7229060	7230060
	x 50	x 50	x 25
06	57 Kč/Ks	66 Kč/Ks	78 Kč/Ks

Hliníkový držák 24 cm.

Hliníkový držák 15 cm., dlouhý základ

Výplň

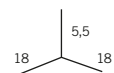
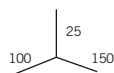
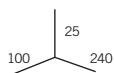

REF.	7231060	7226060	0898060
	x 25	x 25	x 25
06	86 Kč/Ks	73 Kč/Ks	105 Kč/krabice.

Popotahovací tyč (viz. str.174)



**Barvy: 06= bílá.
Kód obalu: 0= velikost.

Japonská stěna v kombinaci s římskou roletou, příslušenství

Stahovací záclona s tyčemi pro japonskou stěnu

REF.	<---->	Kč
7181060	Do 0,90 m.	285 Kč/Ks
7182060	Od 0,90 m.	304 Kč/Ks

Stahovací záclona s páskou pro japonskou stěnu

REF.	<---->	Kč
7184060	Do 0,90 m.	265 Kč/Ks
7185060	Od 0,90 m.	267 Kč/Ks

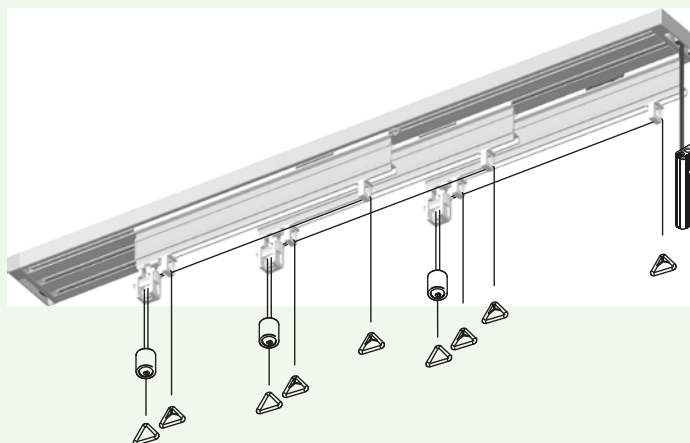
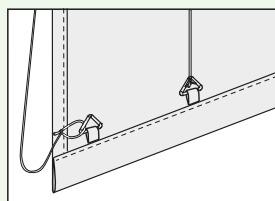
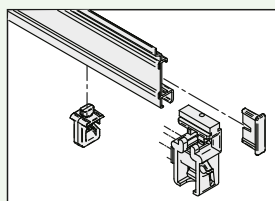

POZNÁMKA: Pro objednání japonské stěny s římskou roletou na míru vyplňte objednávkový formulář (na konci katalogu).

Nosný profil ke stahovací zácloně, 6 m.

Brzda (doporučuje se použít pro ref. 1512060)

Jezdec

Doraz - koncovka

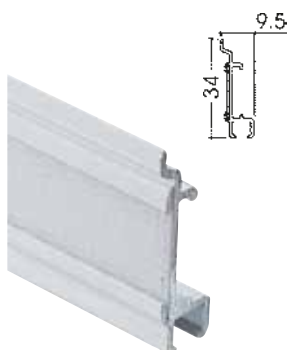

REF. 1132060

0876060

0863060

0941**0

x 20

x 25

x 50

x 50

06 1.183 Kč/Ks
32 -

23 Kč/Ks
-

5 Kč/Ks
-

47 Kč/krabice
47 Kč/krabice

Spojka pro šňůru

Kroužek

Kroužek koncovkový

Šňůra polyester Ø 1 mm (tenká)



REF. 1061060

0805**0

0845**0

1512060

x 25

x 200

x 200

Návin x 300 m.

06 96 Kč/krabice
20 -

169 Kč/krabice
315 Kč/krabice

169 Kč/krabice
260 Kč/krabice

1.056 Kč/Návin
-

**Barvy: 06= bílá. 20= průhledná. 32= šedá.
Kód obalu: 0= velikost.





ESTORES

collection



Zaslepený profil 7347, kompletní set s tyčkami a vodorovnou páskou

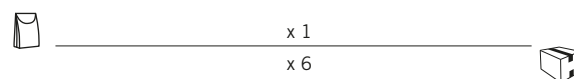
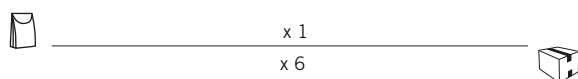

REF.	←----→ Výška 1,80 m.	Kč/balení
7351064	0,60 x 1,80 m. (2 úchyty)	888 Kč/balení
7352064	0,90 x 1,80 m. (2 úchyty)	1.089 Kč/balení
7353064	1,20 x 1,80 m. (2 úchyty)	1.283 Kč/balení
7354064	1,50 x 1,80 m. (3 úchyty)	1.552 Kč/balení
7355064	1,80 x 1,80 m. (3 úchyty)	1.755 Kč/balení
7356064	2,10 x 1,80 m. (4 úchyty)	2.048 Kč/balení

REF.	←----→ Výška 2,40 m.	Kč/balení
7360064	0,60 x 2,40 m. (2 úchyty)	965 Kč/balení
7361064	0,90 x 2,40 m. (2 úchyty)	1.174 Kč/balení
7362064	1,20 x 2,40 m. (2 úchyty)	1.382 Kč/balení
7363064	1,50 x 2,40 m. (3 úchyty)	1.707 Kč/balení
7364064	1,80 x 2,40 m. (3 úchyty)	2.923 Kč/balení
7365064	2,10 x 2,40 m. (4 úchyty)	2.261 Kč/balení

PŘÍSLUŠENSTVÍ: Hliníkový profil, suchý zip, páska pro řasení, navijecí kabel, malá brzda řetězu, hliníková hřídel, kroužky, zátěžová lišta 25x3, polyesterové tyče 4 mm., koncové kroužky, úchyty, koncovky k tyči, koncovky k zátěžové liště, koncovky k profilu, zarážka k řetězku, šrouby, hmoždinky a návod.

Zaslepený profil 7347, kompletní set bez tyček a svislou páskou

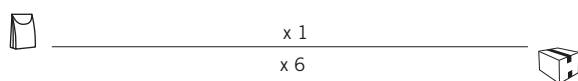

REF.	←----→ Výška 2,40 m.	Kč/balení
7376064	0,60 x 2,40 m. (2 úchyty)	957 Kč/balení
7377064	0,90 x 2,40 m. (2 úchyty)	1.127 Kč/balení
7378064	1,20 x 2,40 m. (2 úchyty)	1.304 Kč/balení
7379064	1,50 x 2,40 m. (3 úchyty)	1.493 Kč/balení
7380064	1,80 x 2,40 m. (3 úchyty)	1.797 Kč/balení
7381064	2,10 x 2,40 m. (4 úchyty)	1.992 Kč/balení
7382064	2,40 x 2,40 m. (4 úchyty)	2.272 Kč/balení
7383064	2,70 x 2,40 m. (5 úchyty)	2.620 Kč/balení
7384064	3,00 x 2,40 m. (5 úchyty)	2.794 Kč/balení

PŘÍSLUŠENSTVÍ: Hliníkový profil, suchý zip, páska s vlasem, naviják se šňůrou, malá brzda řetězu, hliníková hřídel, kroužky, zátěžová lišta 25x3, koncové kroužky, úchyty, koncovky k zátěžové liště, koncovky k profilu, zarážka k řetězku, šrouby, hmoždinky a návod.

POZNÁMKA: Nabízíme i římské rolety s látkami z technické textilie.

**Barvy: 06= bílá.
Kód obalu: 4= ochranný obal.

Profil 7347 s příslušenstvím

Profil 7347



REF. <---> 06

7348060 6 m. x 10 **2.030 Kč/Ks**

7349060 4 m. x 10 **1.354 Kč/Ks**

Čtvercová hliníková hřídel (prut)



REF. <---> 40

7343400 6 m. x 50 **252 Kč/Ks**

7373400 4 m. x 50 **168 Kč/Ks**

Čtyřhranná hliníková hřídel (prut)

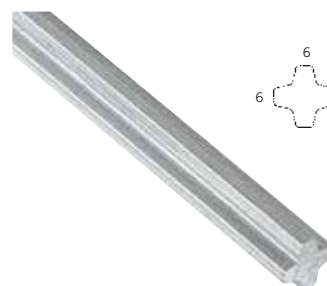

REF. <---> 40

7265400 4 m. x 50 **171 Kč/Ks**

7264400 3 m. x 50 **140 Kč/Ks**

Koncový navíjecí systém 1:2 s víčkem

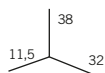
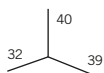

REF. **7369060**

x 25

06 **129 Kč/Ks**

Koncový navíjecí systém 1:4 s víčkem

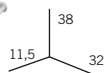
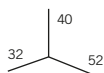

REF. **7350060**

x 25

180 Kč/Ks

Koncový navíjecí systém 1:2 s víčkem a řetízkem

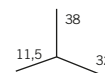
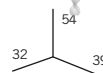

REF. **7420060** **7421060** **7422060**

2,40 m. 3,00 m. 3,60 m.
x 25

198 Kč/Ks **204 Kč/Ks** **211 Kč/Ks**

Navíjací se šňůrou 3 m.

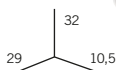

REF. **7370060**

x 25

06 **111 Kč/Ks**

Držák - k uchycení do stěny i do stropu

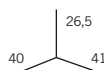

REF. **7371060**

x 50

24 Kč/Ks

Držák automatik - k uchycení do stěny i do stropu

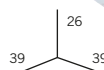

REF. **0498060**

x 25

24 Kč/Ks

Stropní držák automatik

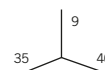

REF. **7474060**

x 25

33,70 Kč/Ks

Novinka

**Barvy: 06= bílá. 40= stříbrná.
Kód obalu: 0= velikost.

Římská roleta se sníženým profilem 864, s tyčkami a vodorovnou páskou

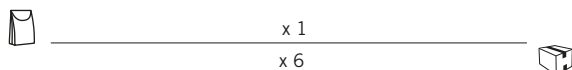

REF.	<---->	Výška 1,80 m.	Kč/balení
2313064	0,60 x 1,80 m. (2 úchyty)		890 Kč/balení
2314064	0,90 x 1,80 m. (2 úchyty)		1.043 Kč/balení
2315064	1,20 x 1,80 m. (2 úchyty)		1.202 Kč/balení
2316064	1,50 x 1,80 m. (3 úchyty)		1.475 Kč/balení
2317064	1,80 x 1,80 m. (3 úchyty)		1.636 Kč/balení
2318064	2,10 x 1,80 m. (4 úchyty)		1.953 Kč/balení
2583064	2,40 x 1,80 m. (4 úchyty)		2.088 Kč/balení

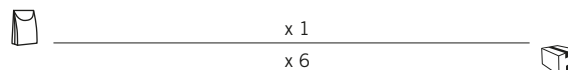

REF.	<---->	Výška 2,40 m.	Kč/balení
2319064	0,60 x 2,40 m. (2 úchyty)		953 Kč/balení
2320064	0,90 x 2,40 m. (2 úchyty)		1.088 Kč/balení
2321064	1,20 x 2,40 m. (2 úchyty)		1.256 Kč/balení
2322064	1,50 x 2,40 m. (3 úchyty)		1.544 Kč/balení
2323064	1,80 x 2,40 m. (3 úchyty)		1.716 Kč/balení
2324064	2,10 x 2,40 m. (4 úchyty)		2.006 Kč/balení
2325064	2,40 x 2,40 m. (4 úchyty)		1.173 Kč/balení

PŘÍSLUŠENSTVÍ: Hliníkový profil, suchý zip, páska pro řazení, navijecí kabel, malá brzda řetězu, hliníková hřídel, kroužky, zátěžová lišta 25x3, polyesterové tyče 4 mm., koncové kroužky, úchyty, koncovky k tyči, koncovky k zátěžové liště, koncovky k profilu, zarážka k řetězku, šrouby, hmoždinky, imbusový klíč a návod.

Římská roleta se sníženým profilem 864, bez tyček, se svislou páskou s kroužky

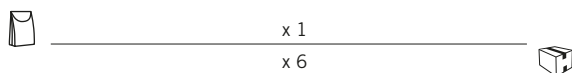

REF.	<---->	Výška 1,80 m.	Kč/balení
2300064	0,60 x 1,80 m. (2 úchyty)		988 Kč/balení
2301064	0,90 x 1,80 m. (2 úchyty)		1.114 Kč/balení
2302064	1,20 x 1,80 m. (2 úchyty)		1.243 Kč/balení
2303064	1,50 x 1,80 m. (3 úchyty)		1.569 Kč/balení
2304064	1,80 x 1,80 m. (3 úchyty)		1.701 Kč/balení
2305064	2,10 x 1,80 m. (4 úchyty)		2.027 Kč/balení
2588064	2,40 x 1,80 m. (4 úchyty)		2.036 Kč/balení

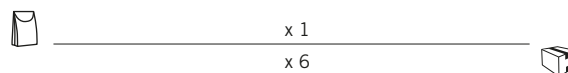

REF.	<---->	Výška 2,40 m.	Kč/balení
2306064	0,60 x 2,40 m. (2 úchyty)		1.056 Kč/balení
2307064	0,90 x 2,40 m. (2 úchyty)		1.170 Kč/balení
2308064	1,20 x 2,40 m. (2 úchyty)		1.299 Kč/balení
2309064	1,50 x 2,40 m. (3 úchyty)		1.653 Kč/balení
2310064	1,80 x 2,40 m. (3 úchyty)		1.785 Kč/balení
2311064	2,10 x 2,40 m. (4 úchyty)		2.139 Kč/balení
2312064	2,40 x 2,40 m. (4 úchyty)		2.265 Kč/balení

PŘÍSLUŠENSTVÍ: Hliníkový profil, suchý zip, navijecí systém s plochou šňůrkou, malá brzda řetězu, čtyřhranná hliníková hřídel, zátěžová lišta 25x3, páska s kroužky, koncové kroužky, úchyty, koncovka k zachycení pásky, koncovky k zátěžové liště, koncovky k profilu, šrouby, hmoždinky, imbusový klíč a návod.

POZNÁMKA: Nabízíme i římské rolety s látkami z technické textilie.

**Barvy: 06= bílá, 40= stříbrná.
Kód obalu: 4= ochranný obal.

Profil 864 s příslušenstvím



Čtyřhranná hliníková hřídel (prut)

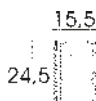

REF.	←---→			06	REF.	←---→			40	REF.	←---→			40
0864060	6 m.	x 40	1.183	Kč/Ks	0864400	6 m.	x 40	1.278	Kč/Ks	7265400	4 m.	x 50	171	Kč/Ks
1099060	4 m.	x 40	789	Kč/Ks	1099400	4 m.	x 40	852	Kč/Ks	7264400	3 m.	x 50	140	Kč/Ks
1098060	3 m.	x 40	592	Kč/Ks	1098400	3 m.	x 40	639	Kč/Ks					
1097060	2 m.	x 40	404	Kč/Ks	1097400	2 m.	x 40	428	Kč/Ks					

Stropní držák (podpěra)

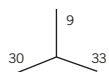

Navijec bez šňůry (Max. 5 m.)

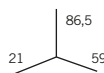

pomalý (bílá) rychlý (červená)

Navijec se šňůrou 3 m.

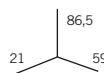

pomalý (bílá) rychlý (červená)

Malá brzda bez řetízku (Max. 2 kg. s 1783/1534) (Max. 4 kg. s 1677/1533)

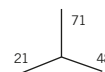

REF.	0993**0	0993**2	1677060	1783060	1533060	1534060	1676060				
	x 50		x 12		x 12		x 6		x 6		x 10
	06	9 Kč/Ks	50 Kč/bl.	117 Kč/Ks	107 Kč/Ks	292 Kč/Ks	284 Kč/Ks	84 Kč/Ks			
	40	8 Kč/Ks	47 Kč/bl.	-	-	-	-	-			

Víčko

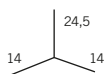

Držák na stěnu

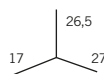

Držák k uchycení na stěnu i do stropu

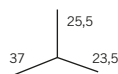

Malá brzda s řetízkem (Max. 4 kg.)

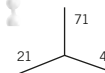

REF.	1508**0	1557060	1509060	1531060	1784060	1532060
	x 50	x 50	x 50	x 6	x 6	x 6
	06	74 Kč/krabice	171 Kč/krabice	6 Kč/Ks	163 Kč/Ks	168 Kč/Ks
	32	101 Kč/krabice	-	-	-	172 Kč/Ks

**Barvy: 06= bílá, 32= šedá, 40= stříbrná.
Kód obalu: 0= velikost, 2= blister.

Římská roleta s profilem 7206, s tyčkami a vodorovnou páskou

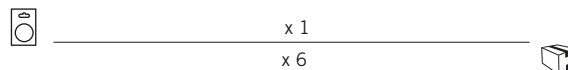
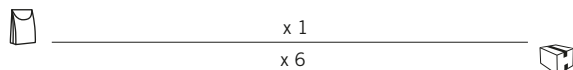

REF.	<---->	Výška 1,80 m.	Kč/balení
1631064	0,60 x 1,80 m. (2 úchyty)		631 Kč/balení
1541064	0,90 x 1,80 m. (2 úchyty)		759 Kč/balení
1542064	1,20 x 1,80 m. (2 úchyty)		905 Kč/balení
1543064	1,50 x 1,80 m. (3 úchyty)		1.072 Kč/balení
1544064	1,80 x 1,80 m. (3 úchyty)		1.230 Kč/balení
1632064	2,10 x 1,80 m. (4 úchyty)		1.402 Kč/balení

REF.	<---->	Výška 1,80 m.	Kč/blister
1541062	0,90 x 1,80 m. (2 úchyty)		831 Kč/bl.
1542062	1,20 x 1,80 m. (2 úchyty)		986 Kč/bl.
1543062	1,50 x 1,80 m. (3 úchyty)		1.169 Kč/bl.
1544062	1,80 x 1,80 m. (3 úchyty)		1.345 Kč/bl.

REF.	<---->	Výška 2,40 m.	Kč/balení
1633064	0,60 x 2,40 m. (2 úchyty)		666 Kč/balení
1547064	0,90 x 2,40 m. (2 úchyty)		821 Kč/balení
1545064	1,20 x 2,40 m. (2 úchyty)		968 Kč/balení
1546064	1,50 x 2,40 m. (3 úchyty)		1.160 Kč/balení
1548064	1,80 x 2,40 m. (3 úchyty)		1.323 Kč/balení
1634064	2,10 x 2,40 m. (4 úchyty)		1.530 Kč/balení

REF.	<---->	Výška 2,40 m.	Kč/blister
1547062	0,90 x 2,40 m. (2 úchyty)		885 Kč/bl.
1545062	1,20 x 2,40 m. (2 úchyty)		1.051 Kč/bl.
1546062	1,50 x 2,40 m. (3 úchyty)		1.258 Kč/bl.
1548062	1,80 x 2,40 m. (3 úchyty)		1.436 Kč/bl.

PŘÍSLUŠENSTVÍ: Kroužky, suchý zip, páska pro řasení, řetízek, šňůra (páska) k navijení, navijecí úchyty, koncovky k profilu, spojka řetízků, čtyřhranná hliníková hřídel (prut), uzda, hliníkové závaží, uzávěry, malá řetězová brzda, hliníkový profil, polyesterové tyče 4 mm., koncovky k tyči, šrouby, hmoždinky, a návod.

Římská roleta s profilem 7206, bez tyček, se svislou páskou s kroužky

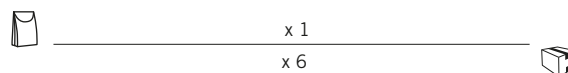
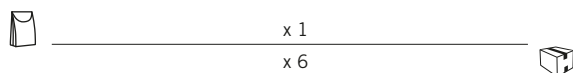

REF.	<---->	06
2339064	0,60 x 1,80 m. (2 úchyty)	713 Kč/balení
2340064	0,90 x 1,80 m. (2 úchyty)	821 Kč/balení
2341064	1,20 x 1,80 m. (2 úchyty)	942 Kč/balení
2342064	1,50 x 1,80 m. (3 úchyty)	1.163 Kč/balení
2343064	1,80 x 1,80 m. (3 úchyty)	1.298 Kč/balení
2344064	2,10 x 1,80 m. (4 úchyty)	1.542 Kč/balení
2611064	2,40 x 1,80 m. (4 úchyty)	1.624 Kč/balení

REF.	<---->	06
2345064	0,60 x 2,40 m. (2 úchyty)	766 Kč/balení
2346064	0,90 x 2,40 m. (2 úchyty)	886 Kč/balení
2347064	1,20 x 2,40 m. (2 úchyty)	1.001 Kč/balení
2348064	1,50 x 2,40 m. (3 úchyty)	1.258 Kč/balení
2349064	1,80 x 2,40 m. (3 úchyty)	1.385 Kč/balení
2350064	2,10 x 2,40 m. (4 úchyty)	1.655 Kč/balení
2351064	2,40 x 2,40 m. (4 úchyty)	1.745 Kč/balení

PŘÍSLUŠENSTVÍ: Kroužky, suchý zip, páska s kroužky, řetízek, šňůra (páska) k navijení, navijecí úchyty, koncovky k profilu, spojka řetízků, čtyřhranná hliníková hřídel (prut), uzda, hliníkové závaží, uzávěry, malá řetězová brzda, hliníkový profil, šrouby, hmoždinky, a návod.

POZNÁMKA: Nabízíme i římské rolety s látkami z technické textilie.

**Barvy: 06= bílá.

Kód obalu: 2= blister. 4= ochranný obal.

Profil 7206 s příslušenstvím

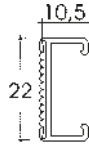

REF.	←----→			06
7206060	6 m.	x 50		960 Kč/Ks
7205060	4 m.	x 50		645 Kč/Ks
7204060	3 m.	x 50		482 Kč/Ks
7203060	2 m.	x 50		323 Kč/Ks

Čtyřhranná hliníková hřídel (prut)



REF.	←----→			40
7265400	4 m.	x 50		171 Kč/Ks
7264400	3 m.	x 50		140 Kč/Ks

Naviják (max. 0,5 kg./3 m.)

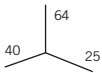

Navijáč se šňůrou 1,85 m.

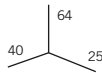

Navijáč se šňůrou 2,45 m.

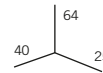

REF.	1536060	2217060	2218060	
	x 25	x 25	x 25	
	06	18 Kč/Ks	53 Kč/Ks	57 Kč/Ks

Malá řetězková brzda (max. 1,5 kg.)

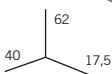

Držák na zeď i do stropu

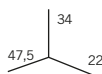

Koncovka profilu

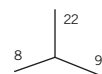

REF.	1538060	1540060	1521060	
	x 25	x 25	x 50	
	06	30 Kč/Ks	11 Kč/Ks	78 Kč/Krabice

**Barvy: 06= bílá. 40= stříbrná.
Kód obalu: 0= velikost.

Římská roleta se sníženým profilem 942, s tyčkami a vodorovnou páskou

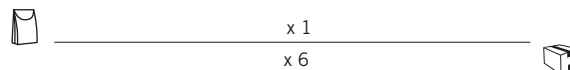
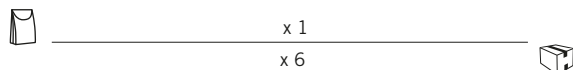

REF.	←----→ Výška 1,80 m.	Kč/balení
2400064	0,60 x 1,80 m. (2 úchyty)	814 Kč/balení
2401064	0,90 x 1,80 m. (2 úchyty)	942 Kč/balení
2402064	1,20 x 1,80 m. (2 úchyty)	1.090 Kč/balení
2404064	1,50 x 1,80 m. (3 úchyty)	1.357 Kč/balení
2405064	1,80 x 1,80 m. (3 úchyty)	1.490 Kč/balení
2406064	2,10 x 1,80 m. (4 úchyty)	1.744 Kč/balení
2407064	2,40 x 1,80 m. (4 úchyty)	1.823 Kč/balení
2408064	2,70 x 1,80 m. (5 úchyty)	2.132 Kč/balení
2409064	3,00 x 1,80 m. (5 úchyty)	2.250 Kč/balení

REF.	←----→ Výška 2,40 m.	Kč/balení
2410064	0,60 x 2,40 m. (2 úchyty)	840 Kč/balení
2411064	0,90 x 2,40 m. (2 úchyty)	978 Kč/balení
2412064	1,20 x 2,40 m. (2 úchyty)	1.134 Kč/balení
2413064	1,50 x 2,40 m. (3 úchyty)	1.419 Kč/balení
2414064	1,80 x 2,40 m. (3 úchyty)	1.566 Kč/balení
2415064	2,10 x 2,40 m. (4 úchyty)	1.812 Kč/balení
2416064	2,40 x 2,40 m. (4 úchyty)	1.907 Kč/balení
2417064	2,70 x 2,40 m. (5 úchyty)	2.235 Kč/balení
2418064	3,00 x 2,40 m. (5 úchyty)	2.370 Kč/balení

PŘÍSLUŠENSTVÍ: Hliníkový profil, koncové kroužky, suchý zip, páska pro řasení, úchyty, malá brzda řetězu, navíječ se šňůrou, hliníková hřídel, šrouby, hmoždinky, hliníkové závaží, polyesterové tyče, koncovky k profilu, koncovky k tyči a uzávěry.

Římská roleta se sníženým profilem 942, bez tyček, se svislou páskou s kroužky

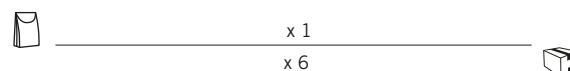
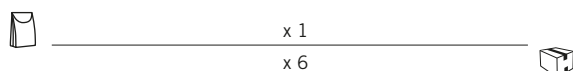

REF.	←----→ Výška 1,80 m.	Kč/balení
2458064	0,60 x 1,80 m. (2 úchyty)	853 Kč/balení
2459064	0,90 x 1,80 m. (2 úchyty)	989 Kč/balení
2460064	1,20 x 1,80 m. (2 úchyty)	1.143 Kč/balení
2461064	1,50 x 1,80 m. (3 úchyty)	1.422 Kč/balení
2462064	1,80 x 1,80 m. (3 úchyty)	1.563 Kč/balení
2463064	2,10 x 1,80 m. (4 úchyty)	1.828 Kč/balení
2464064	2,40 x 1,80 m. (4 úchyty)	1.910 Kč/balení
2465064	2,70 x 1,80 m. (5 úchyty)	2.236 Kč/balení
2466064	3,00 x 1,80 m. (5 úchyty)	2.359 Kč/balení

REF.	←----→ Výška 2,40 m.	Kč/balení
2467064	0,60 x 2,40 m. (2 úchyty)	879 Kč/balení
2468064	0,90 x 2,40 m. (2 úchyty)	1.025 Kč/balení
2469064	1,20 x 2,40 m. (2 úchyty)	1.190 Kč/balení
2470064	1,50 x 2,40 m. (3 úchyty)	1.488 Kč/balení
2471064	1,80 x 2,40 m. (3 úchyty)	1.642 Kč/balení
2472064	2,10 x 2,40 m. (4 úchyty)	1.900 Kč/balení
2473064	2,40 x 2,40 m. (4 úchyty)	1.998 Kč/balení
2474064	2,70 x 2,40 m. (5 úchyty)	2.343 Kč/balení
2475064	3,00 x 2,40 m. (5 úchyty)	2.484 Kč/balení

PŘÍSLUŠENSTVÍ: Hliníkový profil, koncové kroužky, suchý zip, svislá páska s vlasem, držák k uchycení do stěny i do stropu, malá brzda s řetízem, navíječ se šňůrou, čtyřhranná hliníková hřídel (prut), šrouby, hmoždinky, hliníkové závaží, koncovky k profilu a uzávěry.

POZNÁMKA: Nabízíme i římské rolety s látkami z technické textilie.

**Barvy: 06= bílá.
Kód obalu: 4= Ochranný obal.

Profil 942 s příslušenstvím

Profil 942



Čtvercová hliníková hřídel (prut)



Malá brzda s řetízem



REF.	←---→			06	REF.	←---→			40	REF.	řetízek			06
0942060	6 m.	x 50		904 Kč/Ks	7343400	6 m.	x 50		252 Kč/Ks	7339060	2,40 m.	x 10		140 Kč/Ks
0894060	4 m.	x 50		601 Kč/Ks	7373400	4 m.	x 50		168 Kč/Ks	7340060	3,00 m.	x 10		149 Kč/Ks
										7341060	3,60 m.	x 10		158 Kč/Ks

Malá brzda bez řetízku



Navijecí systém



Navijecí systém se šňůrou (páskou) 2,40 m.



REF.	7398060	7342060	7399060	7399200
	x 10	x 20	x 20	x 20
	06	118 Kč/Ks	111 Kč/Ks	130 Kč/Ks
	20	-	-	212 Kč/Ks

Držák na zeď i do stropu



Držák na zeď i do stropu - dlouhý



Koncovka profilu



REF.	2219060	7372060	1945060
	x 50	x 20	x 50
	06	9 Kč/Ks	22 Kč/Ks
			4 Kč/Ks

**Bary: 06= bílá. 20= průhledná.
Kód obalu: 0= velikost.

Příslušenství k římským roletám

Kroužek

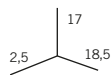

Kroužek s pevným závěsem

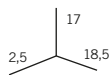

Koncový háček



Kroužek "S"

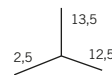

REF.	0805**0	0845**0	1074060	0843060
	x 200	x 200	x 200	x 200
	06 169 Kč/krabice	169 Kč/krabice	153 Kč/krabice	118 Kč/krabice
	20 315 Kč/krabice	260 Kč/krabice	-	-

Průhledný kroužek

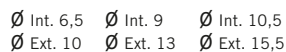

Kroužek s uzdou



Koncovka k zachycení pásky

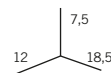

Kovová spojka řetízku



REF.	0798200	0842200	0793200	0844**0	1697060	1566**0
	x 200	x 200	x 200	x 200	x 50	x 50
	06 -	-	-	170 Kč/krabice	101 Kč/krabice	43 222 Kč/kr.
	20 107	118	193 Kč/kr.	399 Kč/krabice	-	44 214 Kč/kr.

Hřídelový kroužek

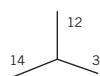

Uzda na hřídel



Zarážka k řetízku

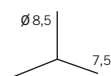

Šňůra polyester



tenká Ø 1 mm. silná Ø1,5 mm.

REF.	7802060	1539060	0866**0	1512060	0823060
	x 100	x 25	x 50	Návin x 300 m.	
	06 89 Kč/krabice	94 Kč/krabice	72 Kč/krabice	1.056 Kč/Ks	1.056 Kč/Ks
	20 -	-	72 Kč/krabice	-	-

**Barvy: 06= bílá, 20= průhledná, 43= chrom, 44= zlatá.
Kód obalu: 0= velikost.

Příslušenství k římským roletám

Plastová spojka řetízku



Bezpečnostní mechanismus

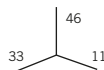

Kleště k manipulaci s kovovým řetízem



Kleště k manipulaci s plastovým řetízem



REF.	7259060	1482060	1603000	1769000
	x 50	x 10	x 1	x 1
			Čisté náklady	Čisté náklady
06	123 Kč/krabice.	22 Kč/Ks	5.263 Kč/Ks	2.392 Kč/Ks

Vodící řetízek 12



Vodící řetízek 6

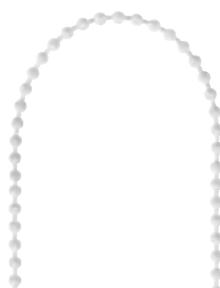

Vodící řetízek kovový 6



Vodící řetízek mosazný 6



REF.	1535060	1650060	1565**0	2209**0
	Návin x 250 m.	Návin x 250 m.	Návin x 150 m.	Návin x 150 m.
06	17 Kč/m.	18 Kč/m.	-	-
44	-	-	62 Kč/m.	101 Kč/m.
43	-	-	41 Kč/m.	91 Kč/m.

Vodící řetízek - neukončený



REF.	←----→		06	43
2132060	1,50 m.	x 10	47 Kč/Ks	-
2133060	2,00 m.	x 10	51 Kč/Ks	-
1694**0	2,40 m.	x 10	58 Kč/Ks	127 Kč/Ks
1693**0	3,00 m.	x 10	62 Kč/Ks	143 Kč/Ks
1695**0	3,60 m.	x 10	66 Kč/Ks	161 Kč/Ks

**Barvy: 06= bílá. 43= chrom. 44= zlatá.
Kód obalu: 0= velikost.

Příslušenství k římským roletám

Hliníková spodní lišta (zátěžová) 24,5 mm

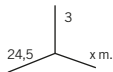

x 50

REF.	←---→	06
1075060	6,00 m.	819 Kč/Ks
7274060	4,00 m.	555 Kč/Ks
7300060	3,00 m.	427 Kč/Ks

Hliníková spodní lišta (zátěžová) 40 mm

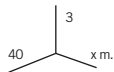

x 50

REF.	←---→	06
1079060	6,00 m.	1.323 Kč/Ks
1100060	4,00 m.	878 Kč/Ks
-	-	-

Polyesterová spodní lišta (zátěžová) 15 mm

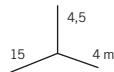

x 100

REF.	←---→	06
-	-	-
0827060	4,00 m.	358 Kč/Ks
-	-	-

Polyesterová spodní lišta (zátěžová) 30 mm

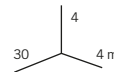

x 50

REF.	←---→	06
-	-	-
0828060	4,00 m.	457 Kč/Ks
-	-	-

Průhledná spodní lišta (zátěžová) 24 mm. x 3 m.

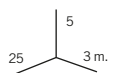

x 50

REF.	←---→	20
-	-	-
-	-	-
7344200	3,00 m.	629 Kč/Ks

Průhledná spodní lišta (zátěžová) 40 mm. x 3 m.

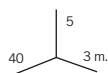

x 50

REF.	←---→	20
-	-	-
-	-	-
7346200	3,00 m.	783 Kč/Ks

Polyesterová tyč 4 mm (balení 100 ks)



x 500

REF.	←---→	20
1077060	6,00 m.	64 Kč/Ks
0821060	4,00 m.	45 Kč/Ks
0820060	3,00 m.	35 Kč/Ks

Transparentní (průsvitná) tyč 4,5 mm x 3 m



x 500

REF.	←---→	20
-	-	-
-	-	-
1213200	3,00 m.	89 Kč/Ks

Protizávažní trubka 12 mm. x 3 m.



REF.	0427060
x 14	
309 Kč/Ks	

Uzávěr 40 X 3

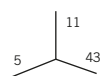

REF.	1779200
x 50	
9 Kč/Ks	

Uzávěr 25 X 3

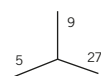

REF.	1772200
x 50	
6 Kč/Ks	

Zátka na tyč 4 mm.



REF.	1699200
x 200	
238 Kč/Krabiice	

**Barvy: 06= bílá. 20= průhledná.
Kód obalu: 0= velikost.

Příslušenství k římským roletám

Uzávěr trubky 12 mm



Malé řetízkové závaží



Malé řetízkové závaží



Novinka

Nůžky na polyesterovou tyč o 4 mm



REF.	0804060	0497060	0490**0	7266070
	x 50	x 10	x 10	
06	62 Kč/Krabice.	31 Kč/Ks	18 Kč/Ks	Čisté náklady 15.188 Kč/Ks
20	-	-	21 Kč/Ks	

Páska s tunelem (k obšití)

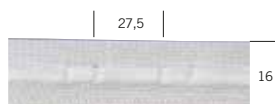

Páska hladká



Hladká šňůrka k navijení



Páska s tunelem (k sešití)



REF.	0053**0	0037**0	1662**0	0104**0
	Návin x 300 m.	Návin x 200 m.	Návin x 200 m.	Návin x 300 m.
06	9 Kč/m.	15 Kč/m.	7 Kč/m.	22 Kč/m.
20	16 Kč/m.	15 Kč/m.	9 Kč/m.	22 Kč/m.
21	9 Kč/m.	15 Kč/m.	-	22 Kč/m.

Suchý zip s vyšším chlupem (1)



Suchý zip klasik (1)



Páska s vlascem



Páska s kroužky



REF.	0991**0	1698060	0031200	0032200
	Návin x 25 m.	Návin x 25 m.	Návin x 200 m.	Návin x 150 m.
06	19 Kč/m.	13 Kč/m.	-	-
07	19 Kč/m.	(Minimální objednávka 250 m.)	-	-
20	-	-	20 Kč/m.	46 Kč/m.
32	18 Kč/m.	-	-	-

(1): Páska **Loop** je pro kombinaci s páskou **Hook**. Páska **Velur** je pro kombinaci s páskou **Setax**. Všechny profily Chyc jsou s lepším povrchem a jdou s páskou **Hook**. Páska **Velur** se může dát dohromady s páskou **Hook**, ale páska **Loop** se nemůže kombinovat s páskou **Setax**.

**Barvy: 06= bílá. 07= černá. 32= šedá. 20= průhledná. 21= béžová.
Kód obalu: 0= velikost.

Římská roleta k uchycení na zed'



S tyčkami a vodorovnou páskou
x 1
x 6

Bez tyček a svislou páskou
x 1
x 6

REF.	←----> Výška 2,40 m.	Kč/balení
7401064	0,60 x 2,40 m. (2 úchyty)	639 Kč/balení
7402064	0,90 x 2,40 m. (2 úchyty)	806 Kč/balení
7403064	1,20 x 2,40 m. (2 úchyty)	976 Kč/balení
7404064	1,50 x 2,40 m. (3 úchyty)	1.162 Kč/balení
7405064	1,80 x 2,40 m. (3 úchyty)	1.341 Kč/balení
7406064	2,10 x 2,40 m. (4 úchyty)	1.540 Kč/balení
7407064	2,40 x 2,40 m. (4 úchyty)	1.659 Kč/balení
7408064	2,70 x 2,40 m. (5 úchyty)	1.854 Kč/balení
7409064	3,00 x 2,40 m. (5 úchyty)	2.022 Kč/balení

REF.	←----> Výška 2,40 m.	Kč/balení
7410064	0,60 x 2,40 m. (2 úchyty)	649 Kč/balení
7411064	0,90 x 2,40 m. (2 úchyty)	795 Kč/balení
7412064	1,20 x 2,40 m. (2 úchyty)	936 Kč/balení
7413064	1,50 x 2,40 m. (3 úchyty)	1.118 Kč/balení
7414064	1,80 x 2,40 m. (3 úchyty)	1.266 Kč/balení
7415064	2,10 x 2,40 m. (4 úchyty)	1.474 Kč/balení
7416064	2,40 x 2,40 m. (4 úchyty)	1.617 Kč/balení
7417064	2,70 x 2,40 m. (5 úchyty)	1.763 Kč/balení
7418064	3,00 x 2,40 m. (5 úchyty)	1.898 Kč/balení

PŘÍSLUŠENSTVÍ: Hliníkový profil, koncové kroužky, suchý zip, páska pro řasení, šňůra, slepý závit, vodiče šňůry, úchyty, spojka šňůry, brzdové dráty, šrouby, hmoždinky, hliníkové závaží, polyesterové tyče 4 mm., koncovky k profilu, koncovky k tyči, uzávěry a dřevěná rukojeť.

PŘÍSLUŠENSTVÍ: Hliníkový profil, koncové kroužky, suchý zip, svislá páska s vlascem, slepý závit, vodiče šňůry, úchyty, spojka šňůry, brzdové dráty, šrouby, hmoždinky, hliníkové závaží, koncovky k profilu, uzávěry a dřevěná rukojeť.

Profil 7393 a příslušenství



S tyčkami a vodorovnou páskou
x 1
x 6

Bez tyček a svislou páskou
x 1
x 6

REF.	←----> Výška 2,40 m.	Kč/balení
7118064	0,60 x 2,40 m. (2 úchyty)	981 Kč/balení
7119064	0,90 x 2,40 m. (2 úchyty)	1.221 Kč/balení
7122064	1,20 x 2,40 m. (2 úchyty)	1.469 Kč/balení
7123064	1,50 x 2,40 m. (3 úchyty)	1.755 Kč/balení
7126064	1,80 x 2,40 m. (3 úchyty)	2.017 Kč/balení
7130064	2,10 x 2,40 m. (4 úchyty)	2.306 Kč/balení
7131064	2,40 x 2,40 m. (4 úchyty)	2.521 Kč/balení
7139064	2,70 x 2,40 m. (5 úchyty)	2.808 Kč/balení
7140064	3,00 x 2,40 m. (5 úchyty)	3.065 Kč/balení

REF.	←----> Výška 2,40 m.	Kč/balení
7141064	0,60 x 2,40 m. (2 úchyty)	1.003 Kč/balení
7142064	0,90 x 2,40 m. (2 úchyty)	1.206 Kč/balení
7149064	1,20 x 2,40 m. (2 úchyty)	1.418 Kč/balení
7150064	1,50 x 2,40 m. (3 úchyty)	1.751 Kč/balení
7156064	1,80 x 2,40 m. (3 úchyty)	1.968 Kč/balení
7157064	2,10 x 2,40 m. (4 úchyty)	2.293 Kč/balení
7158064	2,40 x 2,40 m. (4 úchyty)	2.468 Kč/balení
7159064	2,70 x 2,40 m. (5 úchyty)	2.804 Kč/balení
7160064	3,00 x 2,40 m. (5 úchyty)	3.016 Kč/balení

PŘÍSLUŠENSTVÍ: Hliníkový profil, koncové kroužky, suchý zip, páska pro řasení, šňůra, slepý závit, vodiče šňůry, úchyty, spojka šňůry, brzdové dráty, šrouby, hmoždinky, hliníkové závaží, polyesterové tyče 4 mm., koncovky k profilu, koncovky k tyči, uzávěry a dřevěná rukojeť.

PŘÍSLUŠENSTVÍ: Hliníkový profil, koncové kroužky, suchý zip, svislá páska s vlascem, šňůra, slepý závit, vodiče šňůry, úchyty, spojka šňůry, brzdové dráty, šrouby, hmoždinky, hliníkové závaží, koncovky k profilu, uzávěry a dřevěná rukojeť.

POZNÁMKA: u římské rolety "noc a den" bude vždy zadní s tyčkami.

**Barvy: 06= bílá.
Kód obalu: 4= ochranný obal.

Profil 7393 a příslušenství k těmto roletám

Profil 7393

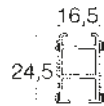

Brzdový drát

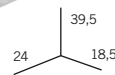

Vodič s kladkou (profil 7393 / 864)

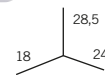

REF.	←----→	x	06
7393060	6 m.	x 40	1.396 Kč/Ks
7374060	4 m.	x 40	933 Kč/Ks
7375060	3 m.	x 40	895 Kč/Ks

REF.	1507060	1506060
	x 25	x 50
06	38 Kč/Ks	7 Kč/Ks

Jednoduchý vodič drátu

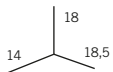

Suchý zip s vyšším chlupem - párováný



20

Uzávěr



Stropní držák (podpěra)



REF.	1511060	1520**0	1508**0	0993**0	0993**2
	x 50	Návin x 25 m.	x 50	x 50	x 2
06	6 Kč/Ks	29 Kč/m.	74 Kč€/krabice	9 Kč/Ks	50 Kč/bl.
07	-	29 Kč/m.	-	-	-
32	-	-	101 Kč/krabice	-	-
40	-	-	-	8 Kč/Ks	47 Kč/bl.

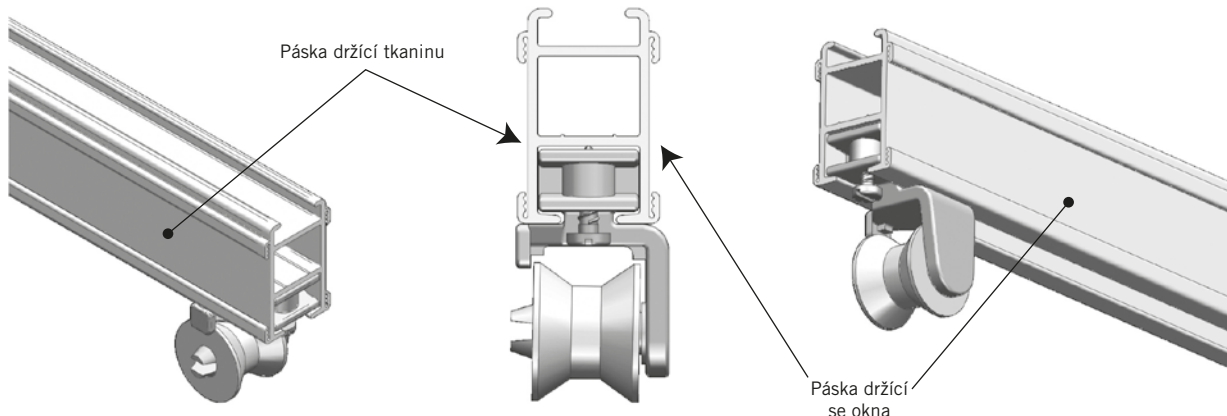

**Barvy: 06= bílá. 07= černá. 32= šedá. 40= stříbrná.
Kód obalu: 0= velikost. 2= blister.

Kompletní římská roleta s profilem 864, tyčkami a vodorovnou páskou

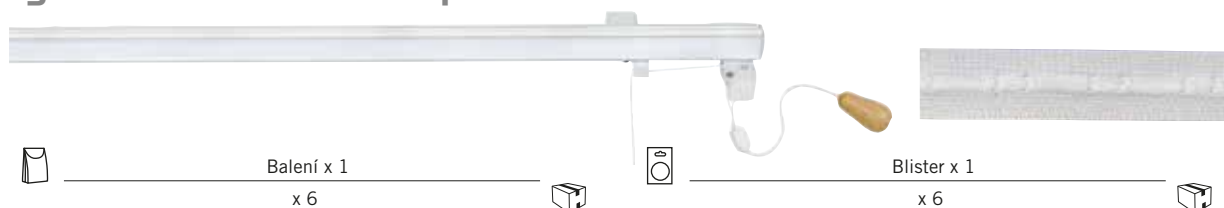

Balení x 1
x 6

Blister x 1
x 6

REF.	<----> Výška 1,80 m.	06	40
1549**4	0,60 x 1,80 m. (2 úchyty)	586 Kč/bal.	582 Kč/bal.
1500**4	0,90 x 1,80 m. (2 úchyty)	736 Kč/bal.	730 Kč/bal.
1501**4	1,20 x 1,80 m. (2 úchyty)	886 Kč/bal.	879 Kč/bal.
1502**4	1,50 x 1,80 m. (3 úchyty)	1.060 Kč/bal.	1.048 Kč/bal.
1503**4	1,80 x 1,80 m. (3 úchyty)	1.212 Kč/bal.	1.198 Kč/bal.
1630**4	2,10 x 1,80 m. (4 úchyty)	1.391 Kč/bal.	1.422 Kč/bal.

REF.	<----> Výška 1,80 m.	06	40
1549**2	0,60 x 1,80 m. (2 úchyty)	615 Kč/bl.	611 Kč/bl.
1500**2	0,90 x 1,80 m. (2 úchyty)	793 Kč/bl.	788 Kč/bl.
1501**2	1,20 x 1,80 m. (2 úchyty)	960 Kč/bl.	951 Kč/bl.
1502**2	1,50 x 1,80 m. (3 úchyty)	1.146 Kč/bl.	1.135 Kč/bl.
1503**2	1,80 x 1,80 m. (3 úchyty)	1.314 Kč/bl.	1.299 Kč/bl.
-	-	-	-

REF.	<----> Výška 2,40 m.	06	40
1621**4	0,60 x 2,40 m. (2 úchyty)	618 Kč/bal.	623 Kč/bal.
1556**4	0,90 x 2,40 m. (2 úchyty)	779 Kč/bal.	774 Kč/bal.
1504**4	1,20 x 2,40 m. (2 úchyty)	939 Kč/bal.	933 Kč/bal.
1505**4	1,50 x 2,40 m. (3 úchyty)	1.125 Kč/bal.	1.118 Kč/bal.
1622**4	1,80 x 2,40 m. (3 úchyty)	1.295 Kč/bal.	1.328 Kč/bal.
1550**4	2,10 x 2,40 m. (4 úchyty)	1.483 Kč/bal.	1.469 Kč/bal.

REF.	<----> Výška 2,40 m.	06	40
1556**2	0,90 x 2,40 m. (2 úchyty)	853 Kč/bl.	846 Kč/bl.
1504**2	1,20 x 2,40 m. (2 úchyty)	1.014 Kč/bl.	1.005 Kč/bl.
1505**2	1,50 x 2,40 m. (2 úchyty)	1.214 Kč/bl.	1.204 Kč/bl.
1622**2	1,80 x 2,40 m. (3 úchyty)	1.395 Kč/bl.	1.296 Kč/bl.
1550**2	2,10 x 2,40 m. (4 úchyty)	1.624 Kč/bl.	1.609 Kč/bl.
-	-	-	-

PŘÍSLUŠENSTVÍ: Hliníkový profil, koncové kroužky, suchý zip, páska pro řasení, šňůra, slepý závit, vodiče šňůry, úchyty, spojka šňůry, brzdové dráty, šrouby, hmoždinky, hliníkové závaží, polyesterové tyče 4 mm., koncovky k profilu, koncovky k tyči, uzávěry a dřevěná rukojeť.

Kompletní římská roleta s profilem 864, se svislou páskou, bez tyček

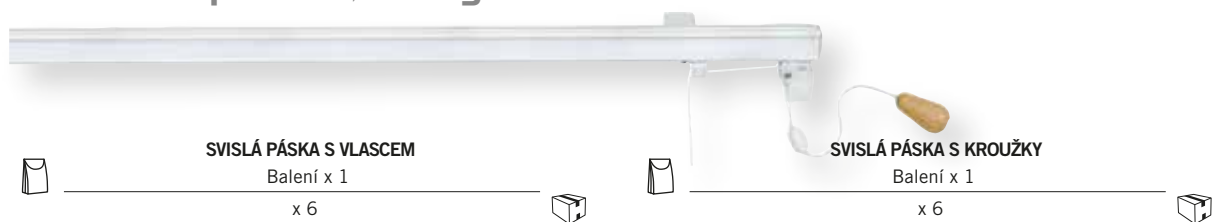

SVISLÁ PÁSKA S VLASCEM
Balení x 1
x 6

SVISLÁ PÁSKA S KROUŽKY
Balení x 1
x 6

REF.	<----> Výška 1,80 m.	06
2326064	0,60 x 1,80 m. (2 úchyty)	592 Kč/balení
2327064	0,90 x 1,80 m. (2 úchyty)	716 Kč/balení
2328064	1,20 x 1,80 m. (2 úchyty)	839 Kč/balení
2329064	1,50 x 1,80 m. (3 úchyty)	1.012 Kč/balení
2330064	1,80 x 1,80 m. (3 úchyty)	1.135 Kč/balení
2331064	2,10 x 1,80 m. (4 úchyty)	1.329 Kč/balení
2578064	2,40 x 1,80 m. (4 úchyty)	1.419 Kč/balení
2579064	2,70 x 1,80 m. (5 úchyty)	1.5150 Kč/balení
2580064	3,00 x 1,80 m. (5 úchyty)	1.607 Kč/balení

REF.	<----> Výška 1,80 m.	06
2480064	0,60 x 1,80 m. (2 úchyty)	642 Kč/balení
2481064	0,90 x 1,80 m. (2 úchyty)	790 Kč/balení
2482064	1,20 x 1,80 m. (2 úchyty)	938 Kč/balení
2483064	1,50 x 1,80 m. (3 úchyty)	1.065 Kč/balení
2484064	1,80 x 1,80 m. (3 úchyty)	1.212 Kč/balení
2485064	2,10 x 1,80 m. (4 úchyty)	1.378 Kč/balení
2486064	2,40 x 1,80 m. (4 úchyty)	1.527 Kč/balení
2487064	2,70 x 1,80 m. (5 úchyty)	1.676 Kč/balení
2488064	3,00 x 1,80 m. (5 úchyty)	1.819 Kč/balení

REF.	<----> Výška 2,40 m.	06
2332064	0,60 x 2,40 m. (2 úchyty)	615 Kč/balení
2333064	0,90 x 2,40 m. (2 úchyty)	740 Kč/balení
2334064	1,20 x 2,40 m. (2 úchyty)	863 Kč/balení
2335064	1,50 x 2,40 m. (3 úchyty)	1.047 Kč/balení
2336064	1,80 x 2,40 m. (3 úchyty)	1.174 Kč/balení
2337064	2,10 x 2,40 m. (4 úchyty)	1.376 Kč/balení
2338064	2,40 x 2,40 m. (4 úchyty)	1.478 Kč/balení
2581064	2,70 x 2,40 m. (5 úchyty)	1.579 Kč/balení
2582064	3,00 x 2,40 m. (5 úchyty)	1.671 Kč/balení

REF.	<----> Výška 2,40 m.	06
2489064	0,60 x 2,40 m. (2 úchyty)	676 Kč/balení
2490064	0,90 x 2,40 m. (2 úchyty)	824 Kč/balení
2491064	1,20 x 2,40 m. (2 úchyty)	973 Kč/balení
2492064	1,50 x 2,40 m. (3 úchyty)	1.099 Kč/balení
2493064	1,80 x 2,40 m. (3 úchyty)	1.245 Kč/balení
2494064	2,10 x 2,40 m. (4 úchyty)	1.412 Kč/balení
2495064	2,40 x 2,40 m. (4 úchyty)	1.561 Kč/balení
2496064	2,70 x 2,40 m. (5 úchyty)	1.709 Kč/balení
2497064	3,00 x 2,40 m. (5 úchyty)	1.855 Kč/balení

PŘÍSLUŠENSTVÍ: Hliníkový profil, koncové kroužky, suchý zip, svislá páska s vlasem, slepý závit, vodiče šňůry, úchyty, spojka šňůry, brzdové dráty, šrouby, hmoždinky, hliníkové závaží, koncovky k profilu, uzávěry a dřevěná rukojeť.

POZNÁMKA: Nabízíme i římské rolety s látkami z technické textilie

**Barvy: 06= bílá. 40= stříbrná.
Kód obalu: 2= blister. 4= ochranný obal.

Profil 864 s příslušenstvím

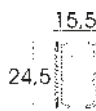

Uzávěr



REF.	←----→			06	REF.	←----→			40
0864060	6 m.	x 40		1.183 Kč/Ks	0864400	6 m.	x 40		1.278 Kč/Ks
1099060	4 m.	x 40		789 Kč/Ks	1099400	4 m.	x 40		852 Kč/Ks
1098060	3 m.	x 40		592 Kč/Ks	1098400	3 m.	x 40		639 Kč/Ks
1097060	2 m.	x 40		404 Kč/Ks	1097400	2 m.	x 40		428 Kč/Ks

REF.	1508**0
	x 50
	06 74 Kč/krabice
	32 101 Kč/krabice

Brzdový drát

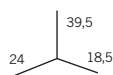

Vodič s kladkou (profil 864)



Jednoduchý vodič drátu

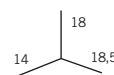

REF.	1507060	0825060	1511060
	x 25	x 50	x 50
06	38 Kč/Ks	9 Kč/Ks	6 Kč/Ks

Držák do zdi

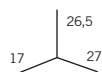

Držák do zdi i stropu

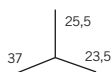

Stropní držák (podpěra)

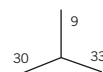

REF.	1557060	1509060	0993**0	0993**2
	x 50	x 50	x 50	x 2
06	171 Kč/krabice	6 Kč/Ks	9 Kč/Ks	50 Kč/bl.
40	-	-	8 Kč/Ks	47 Kč/bl.

**Barvy: 06= bílá. 32= šedá. 40= stříbrná.
Kód obalu: 0= velikost. 2= blister.

Kompletní římská roleta s profilem 7206, tyčkami a vodorovnou páskou



REF.	<----> Výška 1,80 m.	Kč/balení	REF.	<----> Výška 2,40 m.	Kč/balení
1524064	0,90 x 1,80 m. (2 úchyty)	642 Kč/balení	2599064	0,90 x 2,40 m. (2 úchyty)	682 Kč/balení
1525064	1,20 x 1,80 m. (2 úchyty)	782 Kč/balení	1528064	1,20 x 2,40 m. (2 úchyty)	806 Kč/balení
1526064	1,50 x 1,80 m. (3 úchyty)	915 Kč/balení	1529064	1,50 x 2,40 m. (3 úchyty)	967 Kč/balení
1527064	1,80 x 1,80 m. (3 úchyty)	1.075 Kč/balení	2600064	1,80 x 2,40 m. (3 úchyty)	1.157 Kč/balení

PŘÍSLUŠENSTVÍ: Hliníkový profil, koncové kroužky, suchý zip, páska pro řasení, šňůra, slepý závit, vodiče šňůry, úchyty, spojka šňůry, brzdové dráty, šrouby, hmoždinky, hliníkové závaží, polyesterové tyče 4 mm., koncovky k profilu, koncovky k tyči, uzávěry a dřevěná rukojeť.

POZNÁMKA: Nabízíme i římské rolety s látkami z technické textilie

Profil 7206 s příslušenstvím

Profil 7206



REF.	<---->	06
7206060	6 m. x 50	960 Kč/Ks
7205060	4 m. x 50	645 Kč/Ks
7204060	3 m. x 50	482 Kč/Ks
7203060	2 m. x 50	323 Kč/Ks

Brzdové dráty



REF.	1523060	1522060
	x 25	x 50
06	24 Kč/Ks	6 Kč/Ks

Vodič šňůry



Držák do zdi i stropu



REF.	7299060
	x 50
06	6 Kč/Ks

Držák do zdi i stropu, dlouhý

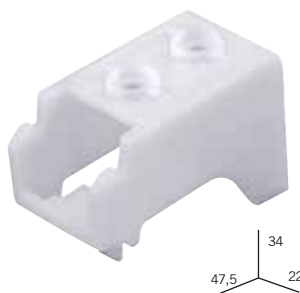

REF.	1540060
	x 25
	11 Kč/Ks

Uzávěr



REF.	1521060
	x 50
	78 Kč/krabice.

**Barvy: 06= bílá.
Kód obalu: 0= velikost. 4= ochranný obal.

Kompletní římská roleta s profilem 909, tyčkami a vodorovnou páskou



REF.	←----> Výška 1,80 m.	Kč/balení	REF.	←----> Výška 2,40 m.	Kč/balení
1513404	0,90 x 1,80 m. (2 úchyty)	638 Kč/balení	2223404	0,90 x 2,40 m. (2 úchyty)	721 Kč/balení
1514404	1,20 x 1,80 m. (2 úchyty)	766 Kč/balení	1517404	1,20 x 2,40 m. (2 úchyty)	819 Kč/balení
1515404	1,50 x 1,80 m. (3 úchyty)	921 Kč/balení	1518404	1,50 x 2,40 m. (3 úchyty)	988 Kč/balení
1516404	1,80 x 1,80 m. (3 úchyty)	1.050 Kč/balení	2224404	1,80 x 2,40 m. (3 úchyty)	1.160 Kč/balení

PŘÍSLUŠENSTVÍ: Hliníkový profil, koncové kroužky, suchý zip, páska pro řasení, šňůra, slepý závit, vodiče šňůry, úchyty, spojka šňůry, brzdové dráty, šrouby, hmoždinky, hliníkové závaží, polyesterové tyče 4 mm., koncovky k profilu, koncovky k tyči, uzávěry a dřevěná rukojeť.

POZNÁMKA: Nabízíme i římské rolety s látkami z technické textilie

Profil 909 s příslušenstvím

Profil 909



REF.	←---->	📦	✍️ 06
0909400	6 m.	x 50	877 Kč/Ks
1090400	4 m.	x 50	586 Kč/Ks
1089400	3 m.	x 50	442 Kč/Ks
1088400	2 m.	x 50	294 Kč/Ks

Spojka



REF.	0824060	0802060
📦	x 25	x 25
✍️ 40	-	-
06	118 Kč/krabice.	22 Kč/Ks

Brzdový drát (3 pozíční)



Vodiče šňůry



Držák do zdi i stropu



Stropní konzolka



Uzávěr



REF.	0803060	0800060	0990060	0801060
📦	x 50	x 50	x 50	x 50
✍️ 06	6 Kč/Ks	8 Kč/Ks	146 Kč/krabice.	70 Kč/krabice.

**Barvy: 06= bílá. 40= stříbrná.
Kód obalu: 0= velikost. 4= ochranný obal.

Kompletní římská roleta s profilem 942, tyčkami a vodorovnou páskou

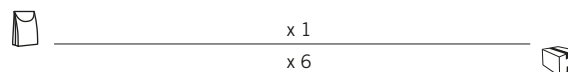
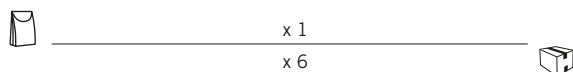

REF.	<----> Výška 1,80 m.	Kč/balení
2380064	0,60 x 1,80 m. (2 úchyty)	509 Kč/balení
2381064	0,90 x 1,80 m. (2 úchyty)	639 Kč/balení
2382064	1,20 x 1,80 m. (2 úchyty)	771 Kč/balení
2384064	1,50 x 1,80 m. (3 úchyty)	912 Kč/balení
2385064	1,80 x 1,80 m. (3 úchyty)	1.046 Kč/balení
2386064	2,10 x 1,80 m. (4 úchyty)	1.215 Kč/balení
2387064	2,40 x 1,80 m. (4 úchyty)	1.293 Kč/balení
2388064	2,70 x 1,80 m. (5 úchyty)	1.434 Kč/balení
2389064	3,00 x 1,80 m. (5 úchyty)	1.552 Kč/balení

REF.	<----> Výška 2,40 m.	Kč/balení
2390064	0,60 x 2,40 m. (2 úchyty)	535 Kč/balení
2391064	0,90 x 2,40 m. (2 úchyty)	673 Kč/balení
2392064	1,20 x 2,40 m. (2 úchyty)	818 Kč/balení
2393064	1,50 x 2,40 m. (3 úchyty)	973 Kč/balení
2394064	1,80 x 2,40 m. (3 úchyty)	1.122 Kč/balení
2395064	2,10 x 2,40 m. (4 úchyty)	1.285 Kč/balení
2396064	2,40 x 2,40 m. (4 úchyty)	1.378 Kč/balení
2397064	2,70 x 2,40 m. (5 úchyty)	1.536 Kč/balení
2398064	3,00 x 2,40 m. (5 úchyty)	1.671 Kč/balení

PŘÍSLUŠENSTVÍ: Hliníkový profil, koncové kroužky, suchý zip, páska pro řasení, šňůra, slepý závit, vodiče šňůry, úchyty, spojka šňůry, brzdové dráty, šrouby, hmoždinky, hliníkové závaží, polyesterové tyče 4 mm., koncovky k profilu, koncovky k tyči, uzávěry a dřevěná rukojeť.

Kompletní římská roleta s profilem 942, se svislou páskou, bez tyček

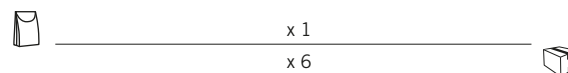
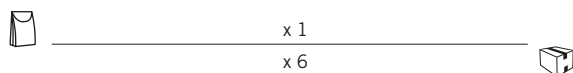

REF.	<----> Výška 1,80 m.	Kč/balení
2440064	0,60 x 1,80 m. (2 úchyty)	470 Kč/balení
2441064	0,90 x 1,80 m. (2 úchyty)	591 Kč/balení
2442064	1,20 x 1,80 m. (2 úchyty)	713 Kč/balení
2443064	1,50 x 1,80 m. (3 úchyty)	857 Kč/balení
2444064	1,80 x 1,80 m. (3 úchyty)	971 Kč/balení
2445064	2,10 x 1,80 m. (4 úchyty)	1.122 Kč/balení
2446064	2,40 x 1,80 m. (4 úchyty)	1.191 Kč/balení
2447064	2,70 x 1,80 m. (5 úchyty)	1.331 Kč/balení
2448064	3,00 x 1,80 m. (5 úchyty)	1.444 Kč/balení

REF.	<----> Výška 2,40 m.	Kč/balení
2449064	0,60 x 2,40 m. (2 úchyty)	499 Kč/balení
2450064	0,90 x 2,40 m. (2 úchyty)	675 Kč/balení
2451064	1,20 x 2,40 m. (2 úchyty)	761 Kč/balení
2452064	1,50 x 2,40 m. (3 úchyty)	912 Kč/balení
2453064	1,80 x 2,40 m. (3 úchyty)	1.043 Kč/balení
2454064	2,10 x 2,40 m. (4 úchyty)	1.197 Kč/balení
2455064	2,40 x 2,40 m. (4 úchyty)	1.244 Kč/balení
2456064	2,70 x 2,40 m. (5 úchyty)	1.423 Kč/balení
2457064	3,00 x 2,40 m. (5 úchyty)	1.559 Kč/balení

PŘÍSLUŠENSTVÍ: Hliníkový profil, koncové kroužky, suchý zip, svislá páska s vlasem, slepý závit, vodiče šňůry, úchyty, spojka šňůry, brzdové dráty, šrouby, hmoždinky, hliníkové závaží, koncovky k profilu, uzávěry a dřevěná rukojeť.

POZNÁMKA: Nabízíme i římské rolety s látkami z technické textilie

**Barvy: 06= bílá.
Kód obalu: 4= ochranný obal.

Profil 942 s příslušenstvím

Profil 942



REF.   06

0942060 6 m. x 50 **904 Kč/Ks**

0894060 4 m. x 50 **601 Kč/Ks**

Brzdový drát

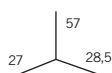

REF. **1943060**

 x 25

 06 **25 Kč/Ks**

Vodič šňůry

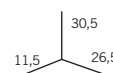

REF. **1944060**

x 50

6 Kč/Ks

Držák do zdi i stropu



REF. **2219060**

 x 50

 06 **9 Kč/Ks**

Držák do zdi i stropu, dlouhý

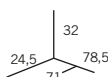

REF. **7372060**

x 20

22 Kč/Ks

Uzávěr

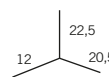

REF. **1945060**

x 50

4 Kč/Ks

**Barvy: 06= bílá.
Kód obalu: 0= velikost.

Římská roleta s profilem 950 (určena k instalaci na kovové tyče o 28 mm)



PŘÍKLAD K POUŽITÍ

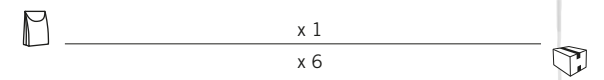

REF.	←----→ Vška 2,40 m.	Kč/balení
2963064	1,20 x 2,40 m. (2 úchyty)	843 Kč/balení
2964064	1,50 x 2,40 m. (3 úchyty)	968 Kč/balení
2965064	1,80 x 2,40 m. (3 úchyty)	1.101 Kč/balení

PŘÍSLUŠENSTVÍ: Hliníkový profil, koncové kroužky, suchý zip, páska pro řasení, šňůra, slepý závit, vodiče šňůry, úchyty, spojka šňůry, brzdové dráty, šrouby, hmoždinky, hliníkové závaží, polyesterové tyče 4 mm., koncovky k profilu, koncovky k tyči, uzávěry a dřevěná rukojeť.

POZNÁMKA: Nabízíme i římské rolety s látkami z technické textilie

Profil 950 s příslušenstvím

Profil 950



14
14,5

Úchyt ke spojení profilu a tyče



17,5
28
11

REF.	←----→	06	REF.	←----→	40
0950060	6 m. x 40	665 Kč/Ks	0950400	6 m. x 40	663 Kč/Ks
1096060	4 m. x 40	445 Kč/Ks	1096400	4 m. x 40	444 Kč/Ks
1095060	3 m. x 40	335 Kč/Ks	1095400	3 m. x 40	334 Kč/Ks
1094060	2 m. x 40	223 Kč/Ks	1094400	2 m. x 40	222 Kč/Ks

REF.	1562400
	x 50
40	731 Kč/krabice.

Brzdový drát



39,5
24
18,5

Vodič šňůry



12
11,5
14

Uzávěr



14,5
11,5
14

REF.	1507060	1560060	1561**0
	x 25	x 50	x 50
06	38 Kč/Ks	202 Kč/krabice.	84 Kč/krabice
20	-	-	101 Kč/krabice

**Barvy: 06= bílá. 20= průhledná. 40= stříbrná.
Kód obalu: 0= velikost. 4= ochranný obal.

Příslušenství k tažným římským roletám

Kroužek

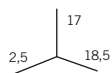

REF. **0805**0**

x 200

06 **169 Kč/krabice**
20 **315 Kč/krabice**

Kroužek s pevným závěsem

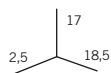

REF. **0845**0**

x 200

169 Kč/krabice
260 Kč/krabice

Koncový háček



REF. **1074060**

x 200

153 Kč/krabice
-

Kroužek "S"

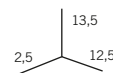

REF. **0843060**

x 200

118 Kč/krabice
-

Průhledný kroužek



Ø Int. 6,5 Ø Int. 9 Ø Int. 10,5
Ø Ext. 10 Ø Ext. 13 Ø Ext. 15,5

REF. **0798200 0842200 0793200**

x 200 x 200 x 200

06 - - -
20 **107** **118** **193 Kč/kr.**

Kroužek s uzdou

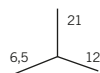

REF. **0844**0**

x 200

170 Kč/krabice
399 Kč/krabice

Spojka pro šňůru



REF. **1061060**

x 25

96 Kč/krabice.
-

Šňůra polyester



tenká Ø1 mm. silná Ø1,5 mm.

REF. **1512060 0823060**

Návin x 300 m.

1.056 Kč/Ks **1.056 Kč/Ks**
- -

Dřevěná rukojeť



REF. **0807**0**

x 25

01 **24 Kč/Ks**
02 **24 Kč/Ks**
06 **25 Kč/Ks**

Plastová rukojeť



REF. **0806060**

x 25

102 Kč/Krabice.

Zvonková rukojeť Ø4,2



REF. **0867060**

x 25

50 Kč/Krabice

Zvonková rukojeť Ø3



REF. **0868060**

x 25

48 Kč/Krabice

**Barvy: 01= vlašský ořech. 02= borovice. 06= bílá. 20= průhledná.
Kód obalu: 0= velikost.

Příslušenství k tažným římským roletám

Hliníková spodní lišta (zátěžová) 24,5 mm.

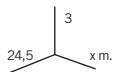

Hliníková spodní lišta (zátěžová) 40 mm.

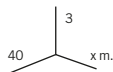

Polyesterová spodní lišta (zátěžová) 15 mm.

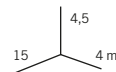
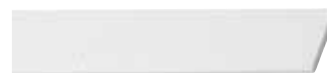

REF.	←---→			06	REF.	←---→			06	REF.	←---→			06
1075060	6,00 m.	x 50		819 Kč/Ks	1079060	6,00 m.	x 50		1.323 Kč/Ks	0827060	4,00 m.	x 100		358 Kč/Ks
7274060	4,00 m.	x 50		555 Kč/Ks	1100060	4,00 m.	x 50		878 Kč/Ks					
7300060	3,00 m.	x 50		427 Kč/Ks										

Polyesterová spodní lišta (zátěžová) 30 mm.

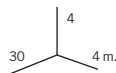

Průhledná spodní lišta (zátěžová) 25 mm. x 3 m.

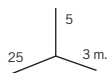

Průhledná spodní lišta (zátěžová) 40 mm. x 3 m.

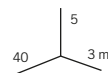

REF.	←---→			06	REF.	←---→			20	REF.	←---→			20
0828060	4,00 m.	x 50		457 Kč/Ks	7344200	3,00 m.	x 50		629 Kč/Ks	7346200	3,00 m.	x 50		783 Kč/Ks

Polyesterová tyč 4 mm. (balení 100 ks)



x 500

Transparentní (průsvitná) tyč 4,5mm x 3m.



x 100

Protizávažní trubka 12 mm x 3 m.



x 14

Uzávěr 40 x 3

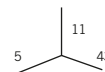
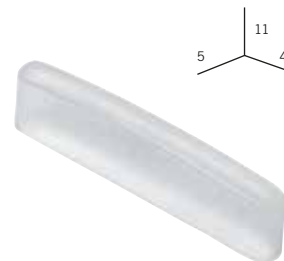

x 50

REF.	←---→		06	REF.	←---→		20	REF.	←---→		06	REF.		20
1077060	6,00 m.		64 Kč/Ks	1213200	3,00 m.		89 Kč/Ks	0427060	3,00 m.		309 Kč/Ks	1779200		9 Kč/Ks
0821060	4,00 m.		45 Kč/Ks											
0820060	3,00 m.		35 Kč/Ks											

**Bary: 06= bílá. 20= průhledná. 40= stříbrná.
Kód obalu: 0= velikost.

Příslušenství k tažným římským roletám

Uzávěr 25 x 3

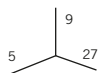

Zátka na tyč 4 mm.



Uzávěr trubky 12 mm



Nůžky na polyesterovou tyč o 4 mm.



REF.	1772200	1699200	0804060	7266070
	x 50	x 200	x 50	
	06 - 20 6 Kč/Ks	- 238 Kč/Krabice	62 Kč/krabice. -	Čisté náklady 15.188 Kč/Ks

Páska s tunelem (k obšití)



Páska hladká



Hladká šňůrka k navíjení



Páska s tunelem (k sešití)



REF.	0053**0	0037**0	1662**0	0104**0
	Návin x 300 m.	Návin x 200 m.	Návin x 200 m.	Návin x 300 m.
	06 9 Kč/m. 20 16 Kč/m. 21 9 Kč/m.	15 Kč/m. 15 Kč/m. 15 Kč/m.	7 Kč/m. 9 Kč/m. -	22 Kč/m. 22 Kč/m. 22 Kč/m.

Suchý zip s vyšším chlupem (1)



Suchý zip klasik (1)



Páska s vlascem



Páska s kroužky



REF.	0991**0	1698060	0031200	0032200
	Návin x 25 m.	Návin x 25 m.	Návin x 200 m.	Návin x 150 m.
	06 19 Kč/m. 07 19 Kč/m. 20 - 32 18 Kč/m.	13 Kč/m. (Minimální objednávka 250 m.) - -	- - 20 Kč/m. -	- - 46 Kč/m. -

(1): Páska **Loop** je pro kombinaci s páskou **Hook**. Páska **Velur** je pro kombinaci s páskou **Setax**. Všechny profily Chyc jsou s lepším povrchem a jdou s páskou **Hook**. Páska **Velur** se může dát dohromady s páskou **Hook**, ale páska **Loop** se nemůže kombinovat s páskou **Setax**.

**Barvy: 06= bílá. 07= černá. 32= šedá. 20= průhledná. 21= béžová.
Kód obalu: 0= velikost.

